



H I G H P E R F O R M A N C E
& S P O R T S R E H A B

WELCOME TO REAXING

REAXING is a philosophy of life and an innovative training methodology based on a patented technology. The innovation of this technology consists in delivering, during the motor gesture, sudden sensory impulses to force and/or encourage the user to react. From this technology was born a line of exclusive products with greater effectiveness than normal equipment and which thus allows to accelerate the training results.



RESULTS AXELERATOR

REAXING PRODUCTS ARE A REAL RESULTS AXELERATOR

Unlike any traditional product, they simultaneously and way more effectively activate the sensory and the neuro motor systems, with better physical, mental and metabolic results.



#TRAIINTOREACT

CONCEPT

PHILOSOPHY_TECHNOLOGY_METHODODOLOGY



PHILOSOPHY

BORN TO REACT

REAXING is a philosophy to deal with the everyday life. Training to react to become resilient to life and to its small and big unexpected daily events. Being Reaxing means being able to face and manage the daily unpredictable challenges by reacting in a positive and proactive way.



KEYWORD
#RESILIENCE

TECHNOLOGY

SUDDEN DYNAMIC IMPULSES

From the movement observation of the everyday life, we have been able to understand that traditional trainings performed in gyms are missing an important component: the unpredictability. They are based on the repetition of predictable, repetitive and constant motor gestures, often performed in conditions of total stability, which do not prepare us for the real needs of life and of the sports we practice. From this movement observation was born the Reaxing technology named **SUDDEN DYNAMIC IMPULSES**.

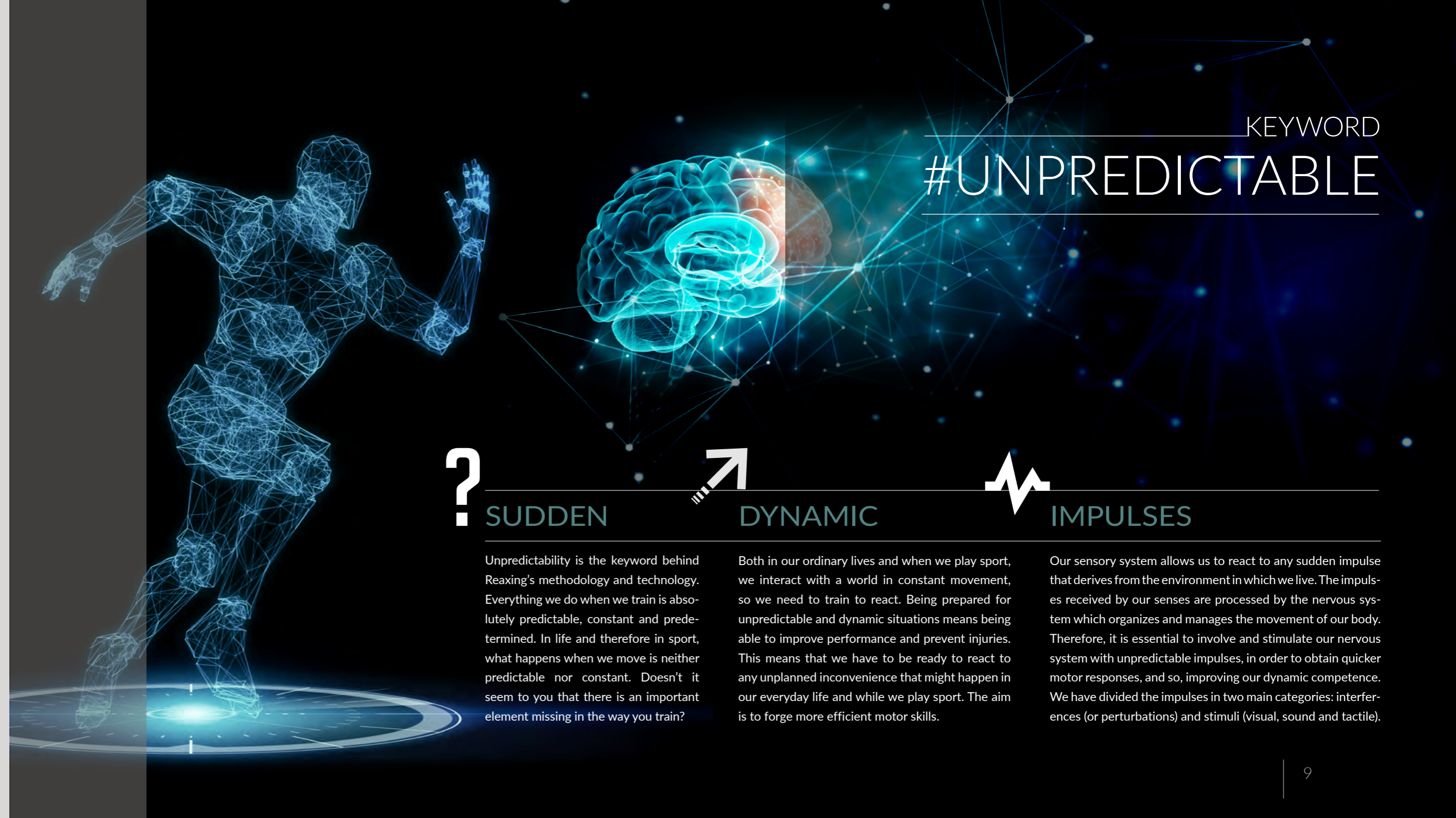
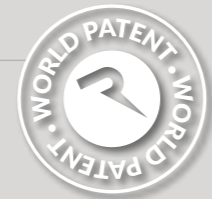

KEYWORD

#UNPREDICTABLE



SUDDEN

Unpredictability is the keyword behind Reaxing's methodology and technology. Everything we do when we train is absolutely predictable, constant and predetermined. In life and therefore in sport, what happens when we move is neither predictable nor constant. Doesn't it seem to you that there is an important element missing in the way you train?



DYNAMIC

Both in our ordinary lives and when we play sport, we interact with a world in constant movement, so we need to train to react. Being prepared for unpredictable and dynamic situations means being able to improve performance and prevent injuries. This means that we have to be ready to react to any unplanned inconvenience that might happen in our everyday life and while we play sport. The aim is to forge more efficient motor skills.



IMPULSES

Our sensory system allows us to react to any sudden impulse that derives from the environment in which we live. The impulses received by our senses are processed by the nervous system which organizes and manages the movement of our body. Therefore, it is essential to involve and stimulate our nervous system with unpredictable impulses, in order to obtain quicker motor responses, and so, improving our dynamic competence. We have divided the impulses in two main categories: interferences (or perturbations) and stimuli (visual, sound and tactile).



interferences & stimuli

 **3D MOTION TECHNOLOGY**

It is the Reaxing patented technology created for generating sudden motor interferences or perturbations on a treadmill (Run) or on a training platform (Board).

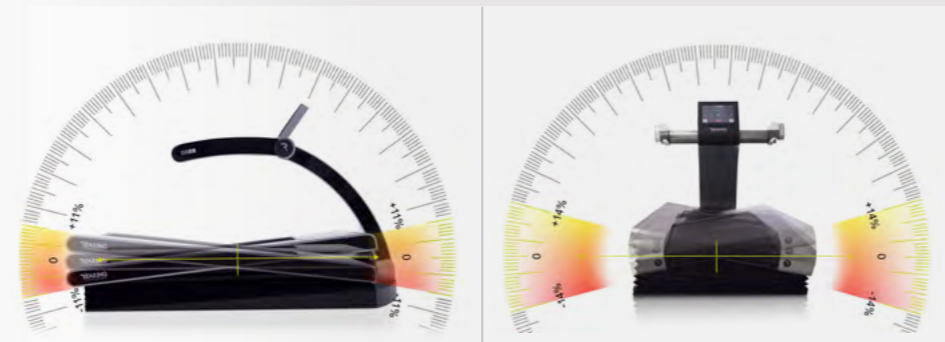

+/- 11%
FRONTAL INCLINATION RANGE

+/- 14%
LATERAL INCLINATION RANGE

 **3D VISION TECHNOLOGY**

It is the Reaxing patented technology created for generating sudden visual stimuli on bright wired or wi-fi satellites (Reax Lights), walls and floors (Reax Lights Pro). The stimuli are finalized at provoking responses by elaborating new motor "solutions", otherwise named voluntary gestures.



MULTI CONNECTION
WIRED OR WIFI - INTEGRATED OR SATELLITES

 **3D WAVE TECHNOLOGY**

It is the Reaxing technology able to generate unpredictable motor interferences during any isotonic exercise, thanks to the movement of a fluid located inside a very high resistance and anti-shock polymer.

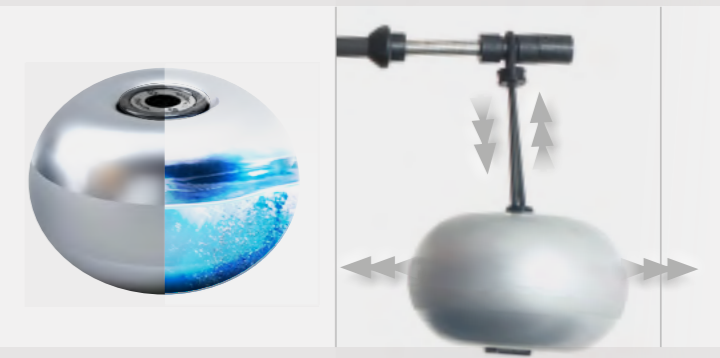

FLUID INSIDE
WAVE IMPULSE

BUNGEE TOOL
REBOUND MOVE

METHODOLOGY

NEUROREACTIVE TRAINING

REAXING METHODOLOGY HAS BEEN NAMED NEUROREACTIVE TRAINING, AS IT IS THE ONLY TRAINING SYSTEM IN THE WORLD THAT FULLY INVOLVES THE SENSORY SYSTEM AND SHIFTS THE FOCUS TO THE NERVOUS SYSTEM.

This allows you to train the neuro motor response to the unpredictability, in an effective and diversified way, with the aim of increasing its speed and "dynamic competence". In synthesis, we could affirm that - as it was at the origins of the human movement - the brain supremacy has been re-established over muscles.

KEYWORD

#TRIPLERTRAINING



NEUROREACTIVE TRAINING

3X

NEUROREACTIVE TRAINING

THE NEUROREACTIVE TRAINING INCLUDES THREE TYPES OF TRAININGS - PROPRIOCEPTIVE, COGNITIVE AND NEUROFUNCTIONAL.

Each training method has its own specific equipment and solutions combined with warm-up and multifunctional zones to complete the training experience.

PROPRIOCEPTIVE TRAINING



COGNITIVE TRAINING



NEUROFUNCTIONAL TRAINING



3X ACTIVATION

BY PERFORMING A NEUROREACTIVE TRAINING YOU MUST GO THROUGH 3 DIFFERENT PHASES:

CONNECTING
Sensory Activation

PROCESSING
Nervous Activation

REACTING
Motor Activation

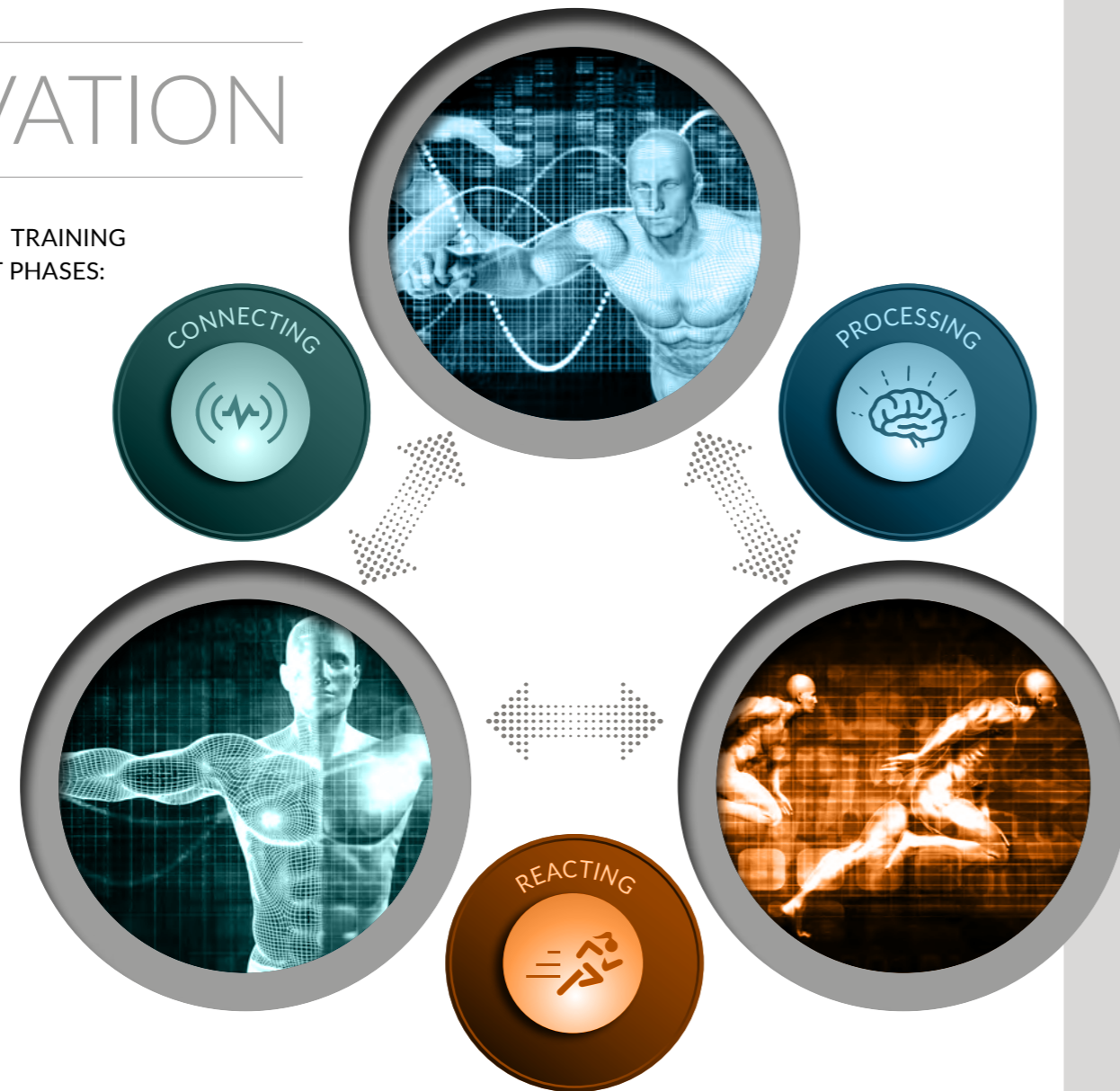

3X EFFECT

THE NEUROREACTIVE TRAINING HAS A TRIPLE EFFECT: BETTER RESULTS AT MENTAL, PHYSICAL AND DYNAMIC COMPETENCE LEVELS.

**+ MENTAL
EFFICIENCY**

Forces the user to stay connected: no distraction, high concentration, frequent cognitive stimuli, ready to react!



**+ PHYSICAL
FUNCTIONALITY**

Activates a greater quantity of muscle fibers and strengthens joints, thus resulting more effective than traditional trainings.



**+ DYNAMIC
COMPETENCE**

Boosts the user's ability to quickly and efficient manage their motor and brain skills.





HIGH PERFORMANCE
& SPORTS REHAB

indoor

APPARATUS ■

NEUROREACTIVE
TRAINING EQUIPMENT



REAX RUN
real running

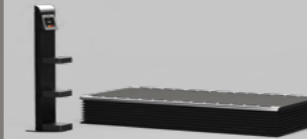

REAX BOARD
the smart floor



REAX 1001
limitless station



REAX LIGHTS
the clever lights



REAX LIFT
the unpredictable load

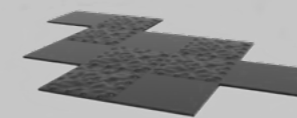

3D MAT
the sensory floor

REAX RUN

REAL RUNNING



REAX RUN

THE ONLY INDOOR TRAINING EXPERIENCE
THAT SIMULATES THE SAME SENSATIONS OF
THE OUTDOOR ENVIRONMENT.



THE ONLY TREADMILL IN THE WORLD THAT PER-
FORMS SUDDEN AND UNPREDICTABLE INCLINA-
TIONS IN ALL DIRECTIONS WHILE RUNNING.



THE ONLY TREADMILL DESIGNED TO LOOK AFTER THE NATURAL NEEDS OF THE HUMAN LOCOMOTION. ONLY WITH THE REAX RUN YOU CAN EXPERIENCE THE SAME sensations OF A REAL OFF-ROAD JOG OR OF A WALK ON A TOUGH ROUTE. IT MAXIMISES THE PROPRIOCEPTIVE FACTORS OF MOVEMENT THROUGH THE WIDE-SPECTRUM MUSCULAR ACTIVATION AND THE CONTROLLED STRESS TO BALANCE. REAX RUN IS DUAL PURPOSE FOR INJURY PREVENTION AND SPORTS PERFORMANCE.

FASTER RESULTS FOR USERS

- > INCREASE OF REACTION RATE AND COORDINATION
- > IMPROVEMENT OF PERFORMANCE AND MOTOR SKILLS
- > GREATER MUSCLE ENGAGEMENT AND DEFINITION
- > HIGHER CALORIES BURN AND METABOLIC ACTIVATION
- > BETTER INJURY RECOVER AND FUNCTIONAL RE-EDUCATION

BETTER RESULTS FOR PROFESSIONALS

- > PROFESSIONAL STANDING IMPROVEMENT
- > INCREASE THE CUSTOMERS ACQUISITION AND RETENTION
- > GREATER PROFIT MARGINS AND ADDITIONAL REVENUES
- > ADDED TRAINING VALUE TO A MULTIPLE CLIENTELE TARGET
- > EXCLUSIVITY AND INNOVATION OF THE SERVICES OFFERED

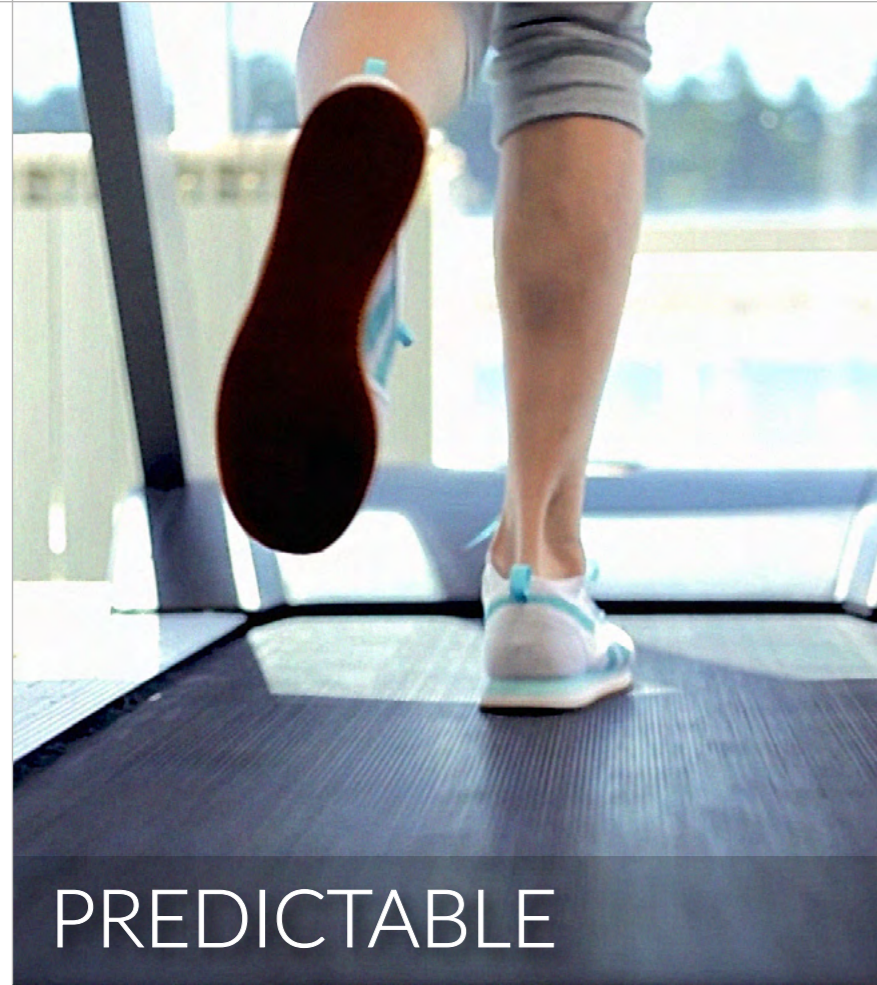

PREDICTABLE

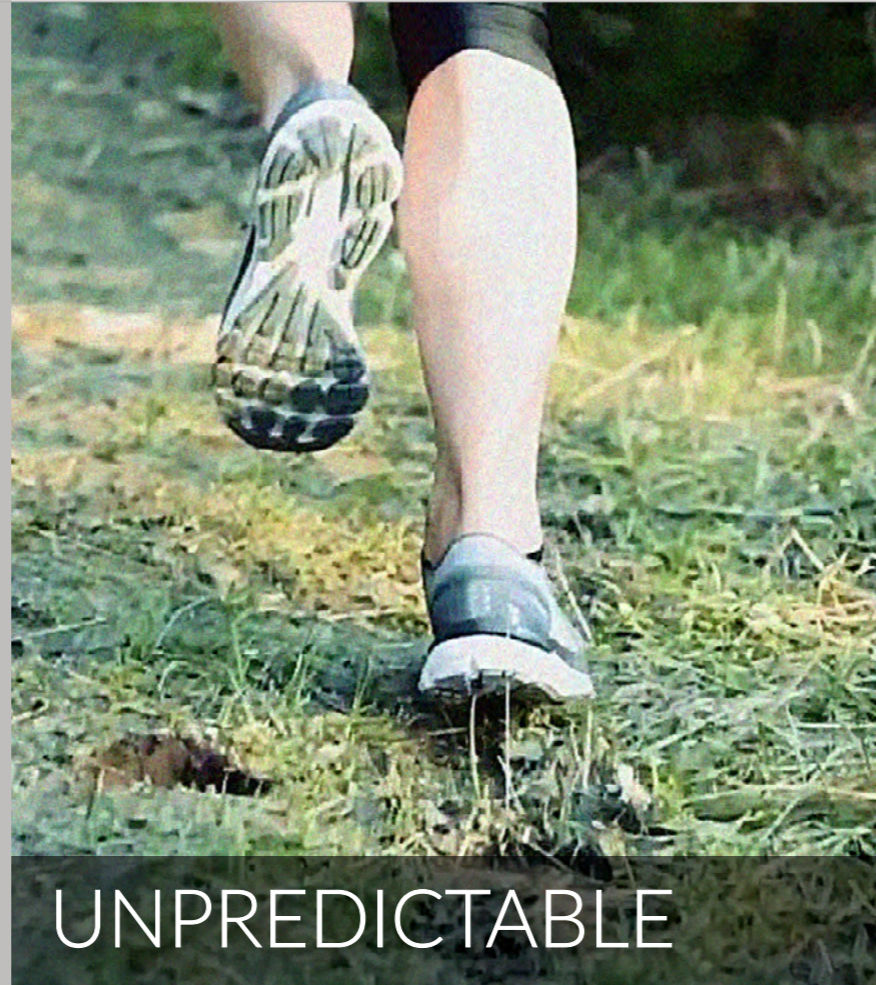

UNPREDICTABLE

A new vision inspired by the real needs of everyday life or sport:
the ability to react to the unpredictable events in constant change.



REAX RUN

The only treadmill with unpredictable dynamic interferences,
for training and movement improvement purposes.

WHY IS IT SO

INNOVATIVE?

THE FIRST PROPRIOCEPTIVE TREADMILL CREATED FOR A CONSTANT VARIATION OF MOVEMENTS.

The interference on the foot, as contact point, is determined by continuous and unpredictable changes in the angle of the belt, improving all the key locomotion factors (walking and running), through a high proprioceptive activation.

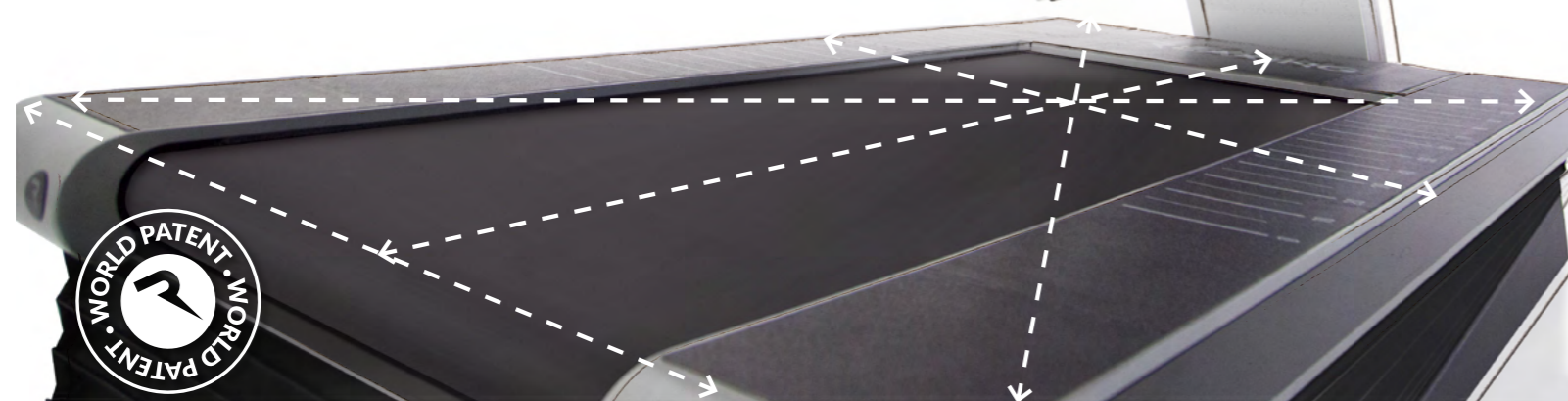
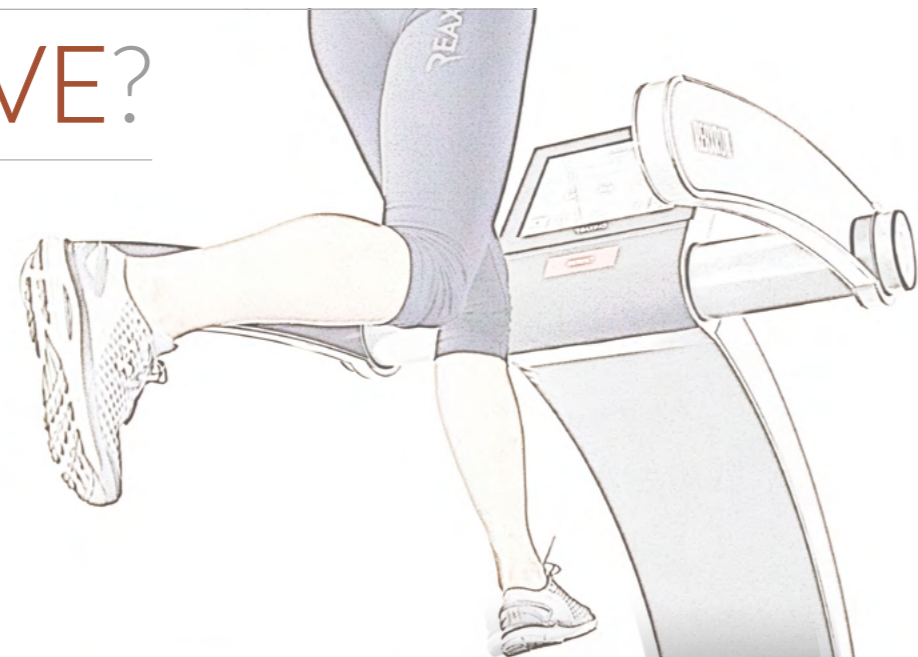

3D MOTION

THE BELT CAN REACH DIFFERENT INCLINATIONS AND ANGLES, THIS MOVEMENT FORCES THE USER TO CONSTANT ADAPTATIONS

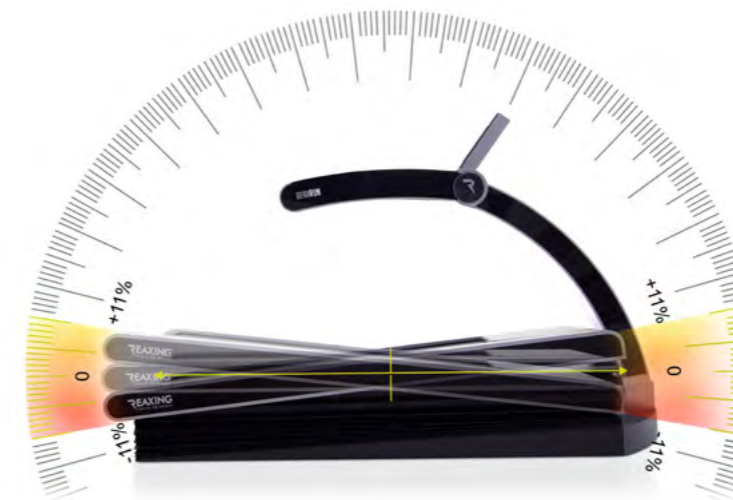

+/- 11% FRONTAL INCLINATION RANGE

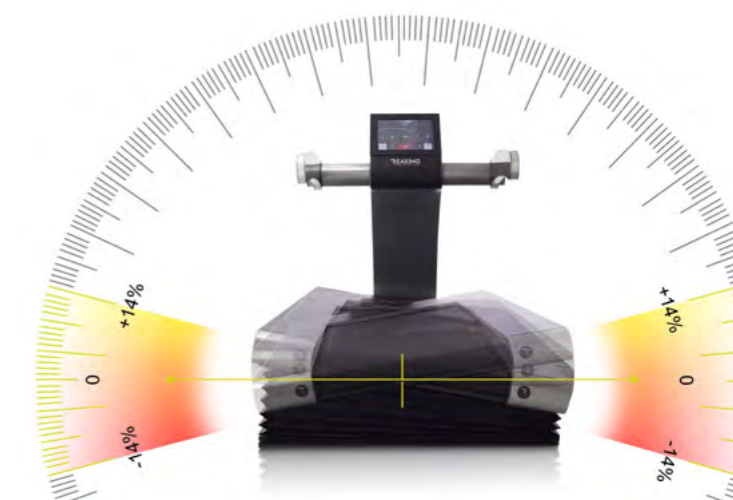

+/- 14% LATERAL INCLINATION RANGE

The movement increases the muscle activation, the engagement of the nervous system and consequently it rises the energy expenditure.

WHY IS IT SO EFFECTIVE?

DYNAMIC AND UNPREDICTABLE INTERFERENCES

The user cannot predict the position of the treadmill and the intensity of the interference. Each step is different and the nervous system is constantly forced to process different sensory information and thus, it produces different motor outputs in order to react more quickly and more efficiently to the typical unexpected events of the outdoor running experience.

- > GLOBAL AND DYNAMIC PROPRIOCEPTIVE STIMULATIONS & FALLS PREVENTION
- > HIGHER CORE INVOLVEMENT & HYPER STIMULATION OF ALL THE POSTURAL MUSCLES



WHY IS IT SO USEFUL FOR PERFORMANCE?

Training with REAX RUN produces greater efficiency in the locomotion. For the standard population, it is an outstanding tool to improve balance and prevent falls. For athletes it can be considered very useful to reach the maximum efficiency level while training.

- > TOTAL, STATIC AND DYNAMIC PROPRIOCEPTIVE ENHANCEMENT
- > HIGHER CALORIES CONSUMPTION AND HIGHER SLIMMING EFFECT
- > HIGHER METABOLIC ACTIVATION



WINNING FEATURES

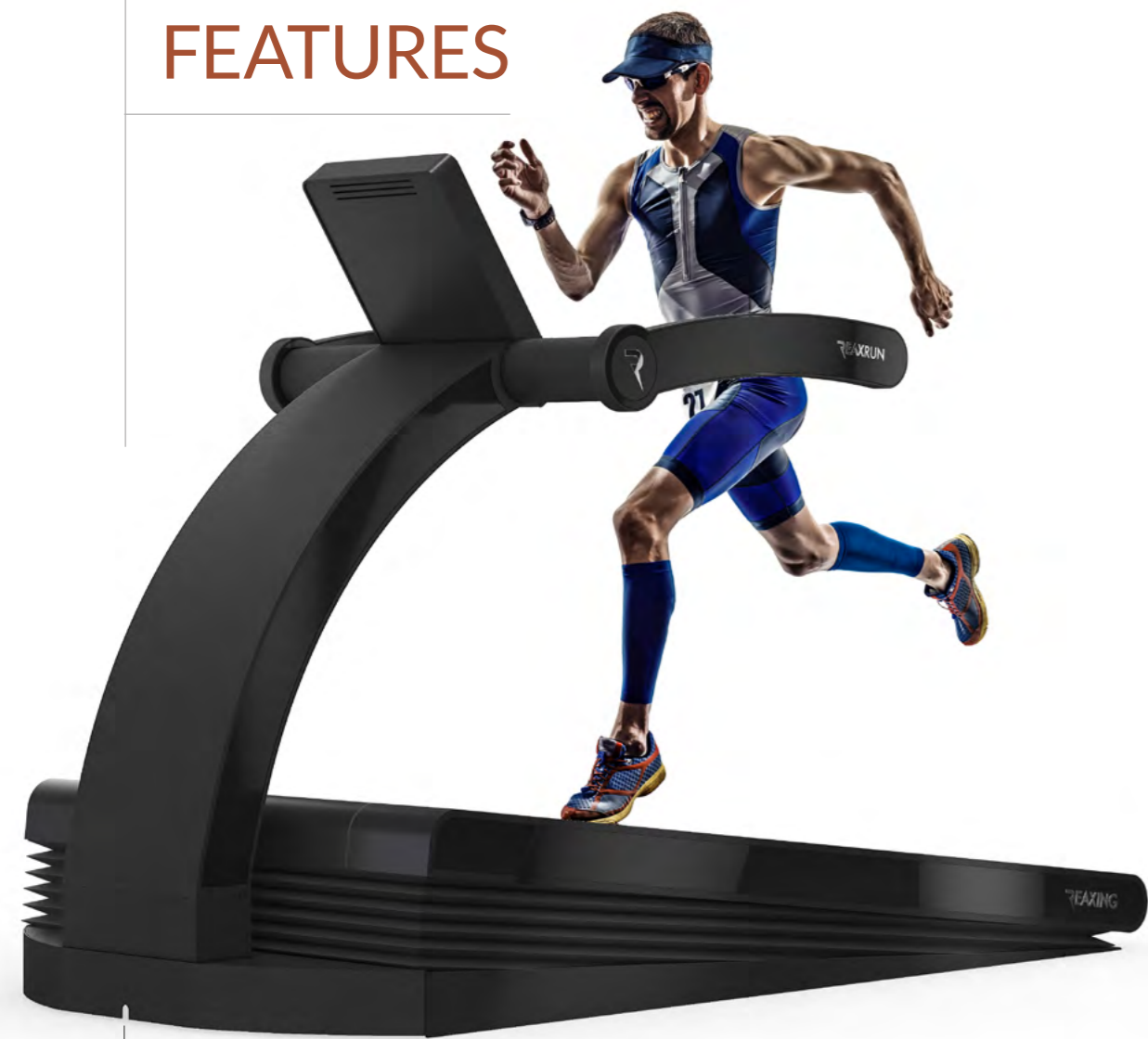

UNIQUE

The only treadmill where you can run as you would do off-road or in the nature.

ORIGINAL

Made in Italy, patented and entirely based on the Italian concept and unique design.

UNPREDICTABLE

1st in the world characterized by the 3D motion and the Sudden Dynamic Impulse technology.

RELIABLE

Attention to details, built using the best materials to make it strong and durable.

USER-FRIENDLY

Intuitive use thanks to our dedicated app. Also, It is possible to remotely control it via tablet.

POWERFUL & SILENT

Equipped with 3 engines, silent even at high speed.

19' HIGH DEFINITION TOUCH SCREEN



Large 19" touch screen to display the several information provided by the software. Select one of the 21 training programs available.

REMOTE AND LIVE CONTROL OPTIONS



The treadmill can also be remotely controlled with your personal tablet by downloading the dedicated app.

SIDE GRAPHICS GUIDES FOR POSITIONING



Useful marks, placed on the wide lateral support, that allow you to evaluate and set the right position for the user.

BELT SHOCK ABSORBING SYSTEM



The shock absorbing system and the wide belt, allow you to experience an incomparable comfort during the step in every situation.



RE 1014



- MAX SPEED: 25 KM/H
- 19" INTEGRATED TOUCH SCREEN
- FRONTAL INCLINATION of +/- 11%
- LATERAL INCLINATION of +/- 14%

WORKING AREA

LENGTH CM | IN
300,00 | 118,11

WIDTH CM | IN
150,00 | 59,06



21 PROGRAMS
FROM SPORTS REHAB TO
HIGH PERFORMANCE

POLAR
HEART RATE MONITORING

**PROPRIOCEPTIVE
PLATFORM**
3D MOTION
TECHNOLOGY

HD MONITOR

LARGE 19" TOUCH SCREEN WHERE YOU CAN CHOOSE THE TRAINING PROGRAM THAT BETTER FITS YOUR GOALS WHILE CHECKING EACH DIFFERENT PARAMETER OF YOUR TRAINING.



- QUICK START
- MANUAL
- FAT LOSS
- GOAL DISTANCE
- GOAL TIME
- GOAL CALORIE
- DOWN HILL
- UP HILL
- HIKING
- FARTLEK I - II - III
- HIIT I - II - III
- TRIAL I - II - III
- CHR
- CADENCE
- PACE



TOTAL CONTROL



LEADING THE GAME

THE INNOVATIVE "LIVE" PROGRAM ALLOWS THE TRAINER TO DIRECTLY AND REMOTELY MANAGE THE INTERFERENCE

LIVE

M O D E



EQUIPMENT SPECIFICATIONS

AUTO STOP	YES
EMERGENCY STOP SYSTEM	YES
ELEVATION SYSTEM	YES
PATENTED MOVEMENT	3D MOTION
BLUETOOTH	YES
ARMS LENGTH OF USE	80 CM 31,49 IN
ROLLER DIAMETER	12 CM 4,72441 IN
MOTOR	2,2 KW 3 HP
MAXIMUM USER WEIGHT	220 KG 485 LB
STEP UP HEIGHT	23 CM 9,05 IN
SPEED RANGE	0,5-25 KM/H
FRONTAL INCLINATION RANGE	+/- 11°
SIDE INCLINATION RANGE	+/- 14°
FRAME COLORS	BLACK
RUNNING SURFACE WIDTH	73 CM 28,74 IN
MONITOR SIZE	19" LCD - WIDE 16:9

EQUIPMENT DIMENSION

WIDTH	117 CM 46,063 IN
LENGTH	244 CM 96,063 IN
HEIGHT	172 CM 67,717 IN



POWER REQUIREMENTS

INTERNATIONAL 240 VAC	YES
USA AND CANADA 110 VCA	YES
POWER CABLE LENGTH	1,5 M

REGULATORY

41	CE SI
----	-------



Just tap start and go.

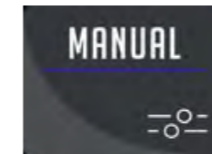

You can set: time, interference or gradient, male or female, age, weight, predictable or unpredictable.

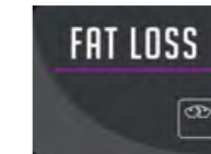

You can set: bpm, total time, interference or gradient, male or female, age, weight, predictable or unpredictable.

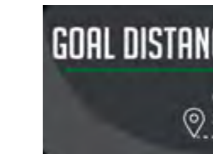

You can set: distance in km, time, interference or gradient, male or female, age, weight, predictable or unpredictable.



You can set: total time in minutes, interference or gradient, male or female, age, weight, predictable or unpredictable.

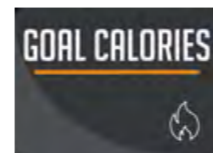

You can set: how many calories do you want to burn, interference or gradient, male or female, age, weight, predictable or unpredictable.

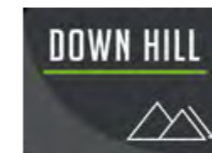

16 minutes program with negative gradient. You can set: male or female, age, weight.



16 minutes program with positive gradient. You can set: male or female, age, weight.

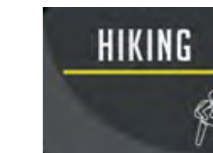

17 minutes program. All parameters can be set.

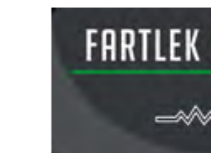

15 minutes program with positive gradient / 3 levels. You can set: interference or gradient, male or female, age, weight.

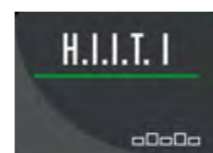

16 minutes program / 3 levels. You can set: speed, interference or gradient, male or female, age, weight, predictable or unpredictable.



20 minutes program / 3 levels. You can set: speed, interference or A, male or female, age, weight, predictable or unpredictable.

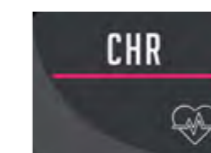

You can set: bpm, total time, interference or gradient, male or female, age, weight, predictable or unpredictable.

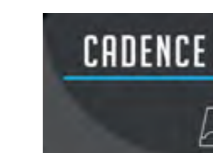

You can set: step per minutes, total time, interference or gradient, male or female, age, weight.

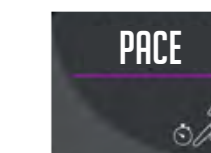

You can set: min/km or km/h, total time, interference or gradient, male or female, age, weight.

REAX BOARD

THE SMART FLOOR

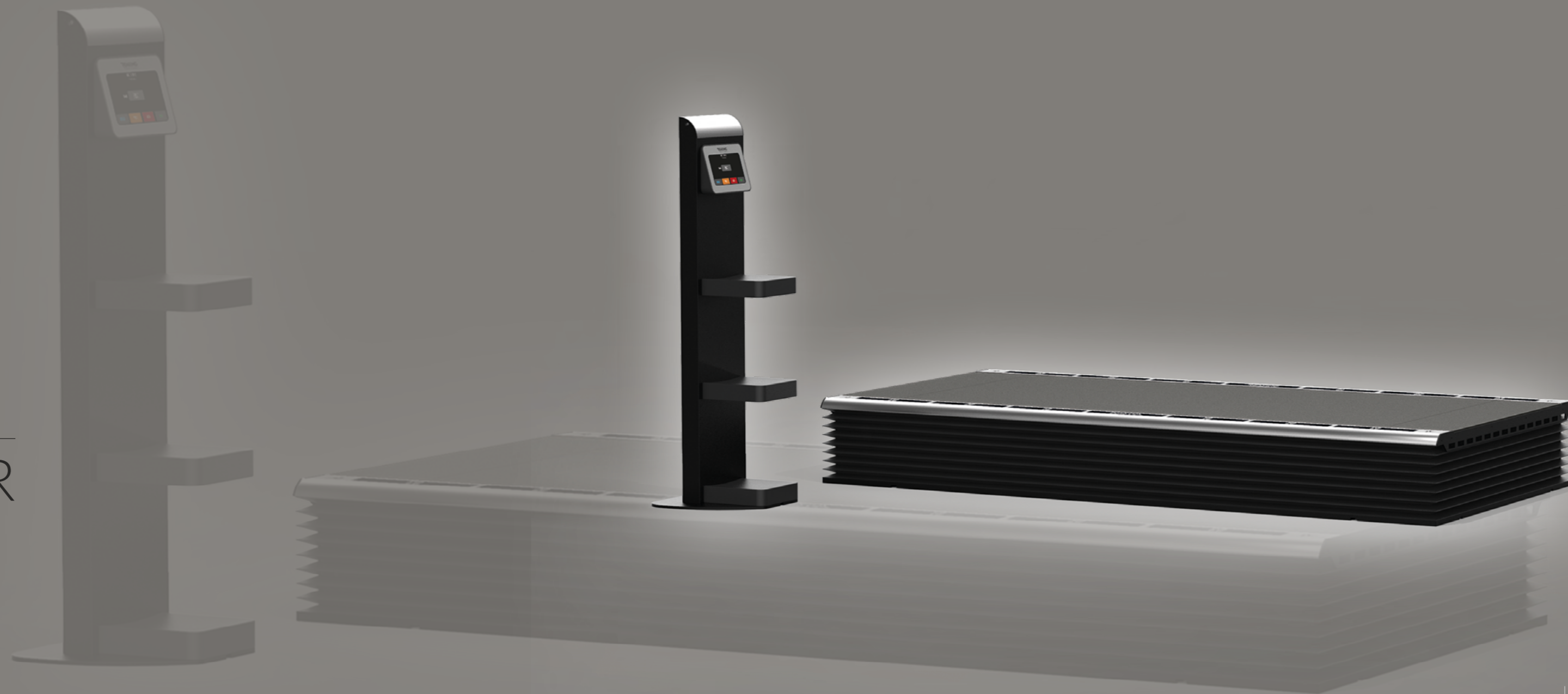



REAX BOARD

PERFORM ANY EXERCISE ON THIS SMART FLOOR AND GET A TRIPLE EFFECT FROM YOUR WORKOUT. IMPROVE PROPRIOCEPTION AND ACQUIRE COMPLETE DYNAMIC MOTOR SKILLS.

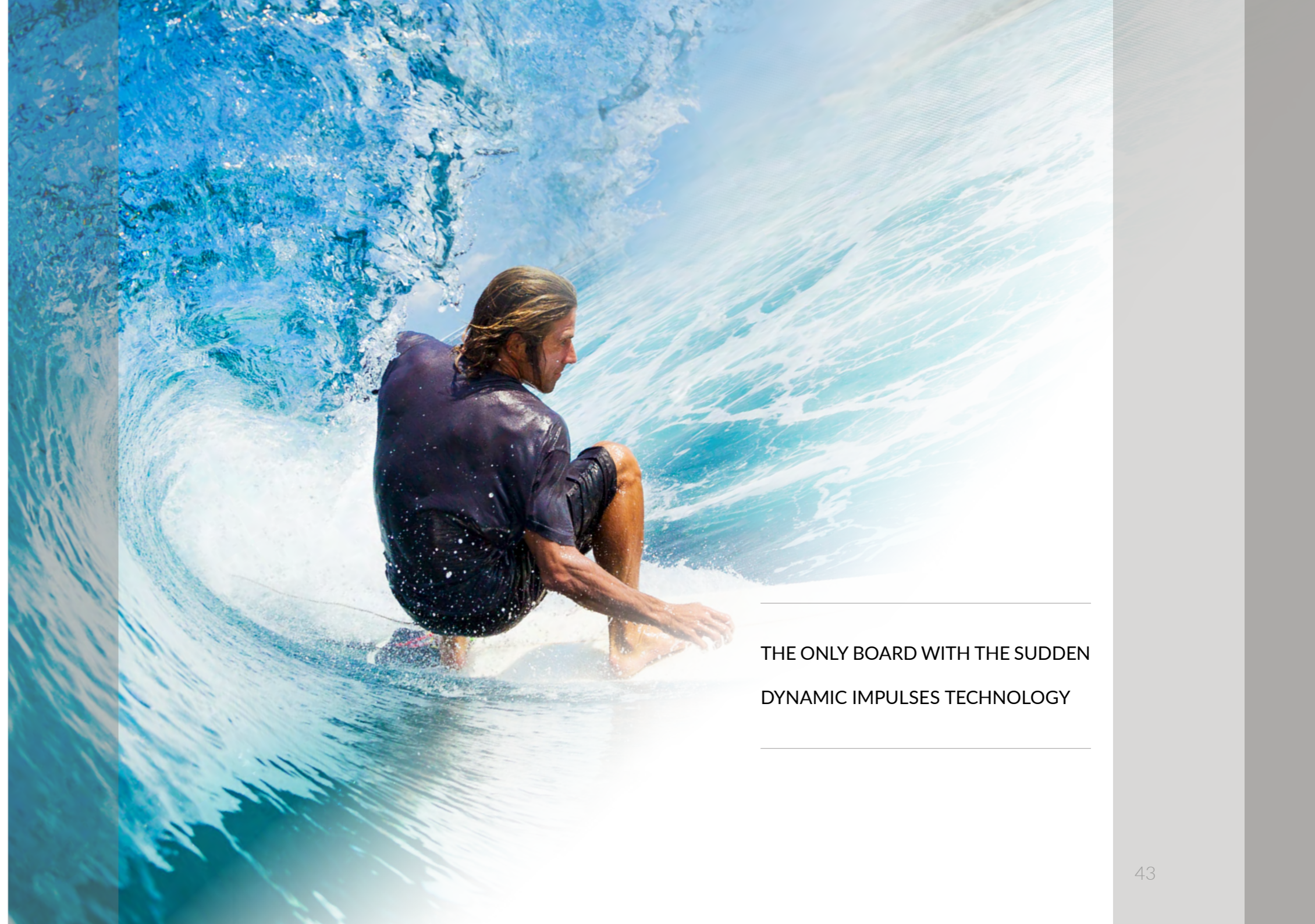

THE ONLY BOARD WITH THE SUDDEN DYNAMIC IMPULSES TECHNOLOGY



REAX BOARD IS THE PATENTED "SMART FLOOR" ABLE TO GENERATE SUDDEN DYNAMIC INTERFERENCES DURING THE EXERCISE. EACH WORKOUT REACHES THE HIGHEST NEUROMUSCULAR INTENSITY LEVEL WITH ENDLESS TRAINING SOLUTIONS. STANDARD EXERCISES, PERFORMED UNDER STABLE AND PREDICTABLE CONDITIONS, BECOME UNPREDICTABLE, EFFECTIVE AND MUCH MORE INTENSE: ALL THE MUSCLES INVOLVED DURING THE EXERCISE ARE ACTIVATED AND THE FOCUS MUST BE KEPT HIGH AND STEADY.

FASTER RESULTS FOR USERS

- > INCREASE OF REACTION RATE AND COORDINATION
- > IMPROVEMENT OF PERFORMANCE AND MOTOR SKILLS
- > GREATER MUSCLE ENGAGEMENT AND DEFINITION
- > HIGHER CALORIES BURN AND METABOLIC ACTIVATION
- > BETTER INJURY RECOVER AND FUNCTIONAL RE-EDUCATION

BETTER RESULTS FOR PROFESSIONALS

- > PROFESSIONAL STANDING IMPROVEMENT
- > INCREASE THE CUSTOMERS ACQUISITION AND RETENTION
- > GREATER PROFIT MARGINS AND ADDITIONAL REVENUES
- > ADDED TRAINING VALUE TO A MULTIPLE CLIENTELE TARGET
- > EXCLUSIVITY AND INNOVATION OF THE SERVICES OFFERED



THE REAX BOARD WAS BORN FROM A REVOLUTIONARY IDEA: transforming a stable and predictable training environment into an unstable and unpredictable one to perform any type of exercise.



UNPREDICTABLE

WHY IS IT SO INNOVATIVE?

THE FIRST AND ONLY TRAINING SURFACE THAT CONSTANTLY VARIES INCLINATION in all directions with the exclusive 3D MOTION technology. Any exercise performed on the Reax Board amplifies the athlete's metabolic, sensory and nervous activity.



3D MOTION

THE REAX BOARD IS THE ONLY SMART FLOOR WITH 3D MOTION TECHNOLOGY THAT PERFORMS SUDDEN INCLINATIONS IN EVERY DIRECTION.

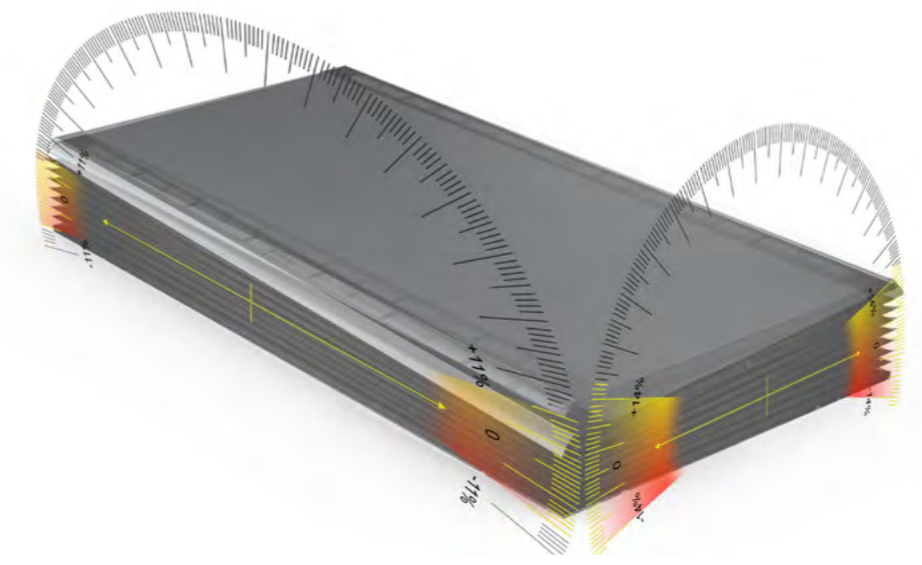

Due to the variation of the inclination and the training planes, the user is forced to a constant adaptation for a real **NEUROREACTIVE TRAINING**. Each movement requires a higher muscular activation and nervous system engagement, resulting in greater energy consumption.

WHY IS IT SO EFFECTIVE?

EVERYTHING BECOMES MORE CHALLENGING. The users cannot predict the type and intensity of the interference, so their brains are forced to build up, step by step, new motor automatisms to react faster and way more effectively to unforeseen events.



WHY IS IT SO USEFUL FOR PERFORMANCE?

THE REAX BOARD, THANKS TO THE HIGHER IMPULSES, PRODUCES A GREATER NEUROMOTOR EFFICIENCY IN ELABORATING AND RESPONDING TO THE STIMULI ORIGINATED BY THE ENVIRONMENT.

- > HIGH PROPRIOCEPTIVE STIMULATION
- > HIGH POSTURAL ACTIVATION
- > HIGHEST CORE INVOLVEMENT
- > INCREASED METABOLIC ACTIVITY
- > INCREASED ENERGY EXPENDITURE
- > MORE MUSCLE FIBRE INVOLVEMENT
- > IMPROVED NEURAL EFFICIENCY
- > CONSISTENT BALANCE IMPROVEMENT
- > FALLS PREVENTION



WINNING FEATURES

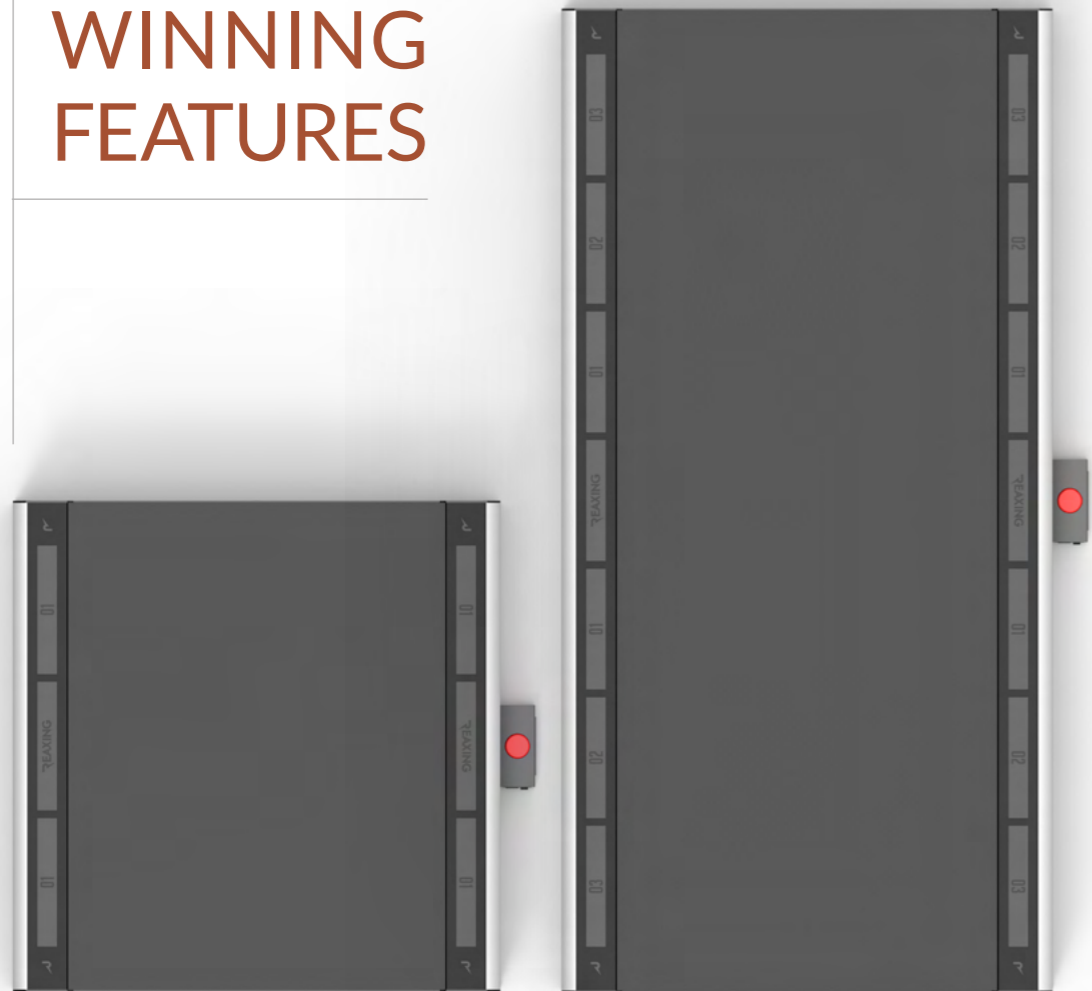

- UNIQUE**
the only smart floor in the market able to offer 3D movements.
- ORIGINAL**
Made in Italy, patented and entirely based on the Italian concept and unique design.
- UNPREDICTABLE**
1st in the world characterized by the **3D motion** and the **Sudden Dynamic Impulse technology**
- RELIABLE**
Attention to details, built using the best materials to make it strong and durable.
- USER-FRIENDLY**
Intuitive use thanks to our dedicated app. Also, It is possible to remotely control it via tablet.
- POWERFUL & SILENT**
Equipped with 2 engines, silent even at high level of interferences.

TECHNICAL GRAPHICS



Side marks to identify the correct position

ANCHORING TOOLS



Anchoring for accessories and training tools

HIGH QUALITY SURFACE

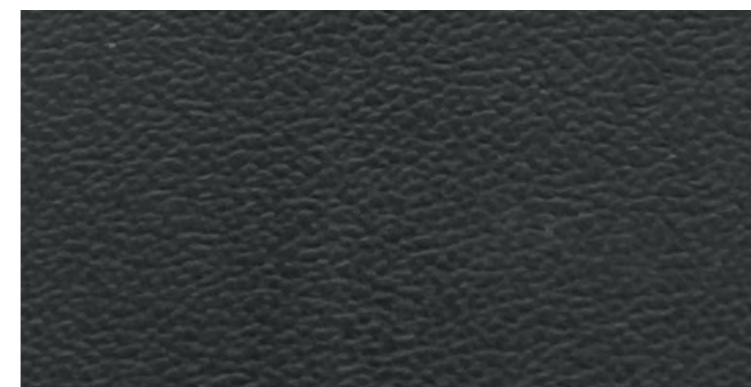

Extra resistance rubber surface with high grip

SHOCK ABSORB SURFACE



Soft surface version available on request

REAX BOARD 250

RE 1015



- CM 250 X 125
- IN 49,21 X 98,42
- FRONTAL INCLINATION OF +/- 11%
- LATERAL INCLINATION OF +/- 14%

REAX BOARD 125

RE 1016



- CM 125 X 125
- IN 49,21 X 49,21
- FRONTAL INCLINATION OF +/- 11%
- LATERAL INCLINATION OF +/- 14%

CONTROL STATION 4

RE 1018



TABLET

RE 1000



EXTRA PRICE SOFT SURFACE VERSION

RE 1019



CHOOSE YOUR
SMART
FLOOR

SOLUTION

RE 5014	PRO1 250 TOUCH
RE 5015	PRO1 250 TABLET
RE 5016	PRO2 125 TOUCH
RE 5017	PRO2 125 TABLET



RE 5014 REAX BOARD

PRO1 250 TOUCH

1 RE 1015
1 RE 1018

REAX BOARD 250
CONTROL STATION 4

OPTIONAL

RE 1019
RE 1000

EXTRA PRICE SOFT SURFACE VERSION
TABLET

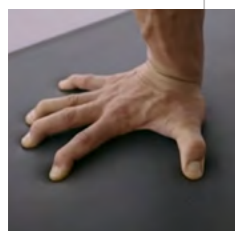

RE 5015 REAX BOARD

PRO1 250 TABLET

1 RE 1015
1 RE 1000

REAX BOARD 250
TABLET

OPTIONAL

RE 1019

EXTRA PRICE SOFT SURFACE VERSION

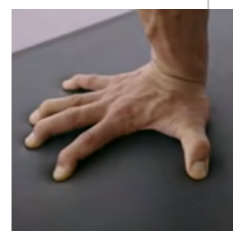

RE 5016

REAX BOARD

PRO2 125 TOUCH

1 RE 1016
1 RE 1018

REAX BOARD 125
CONTROL STATION 4

OPTIONAL

RE 1000

TABLET



RE 5017

REAX BOARD

PRO2 125 TABLET

1 RE 1016
1 RE 1000

REAX BOARD 125
TABLET



CONTROL SYSTEMS

- TABLET
- TOUCH STATION
- TOWER CONTROL STATION



PROFESSIONAL USE

TABLET

THE REAX BOARD APP WAS CONCEIVED TO DELIVER THE BEST EXPERIENCE TO TRAINERS AND USERS. THE APP FITS THE MOST COMMON REQUESTS IN THE PROFESSIONAL FIELD.



14 DIFFICULTY LEVELS

PRE-SET MODE AND PT MODE FOR MANUAL INTERFERENCE CONTROL

LOW LEVEL
1 - 2 - 3 - 4 - 5

MEDIUM LEVEL
6 - 7 - 8 - 9 - 10

HIGH LEVEL
11 - 12 - 13 - 14

PT MODE

- SPECIAL APP INCLUDED
- PRE-SET PROGRAMS
- LIVE MODE CONTROL
- USER FRIENDLY INTERFACE



LEADING THE GAME

THE EXCLUSIVE LIVE PROGRAM ALLOWS THE TRAINER TO REMOTELY CONTROL ALL THE DYNAMIC INTERFERENCES.

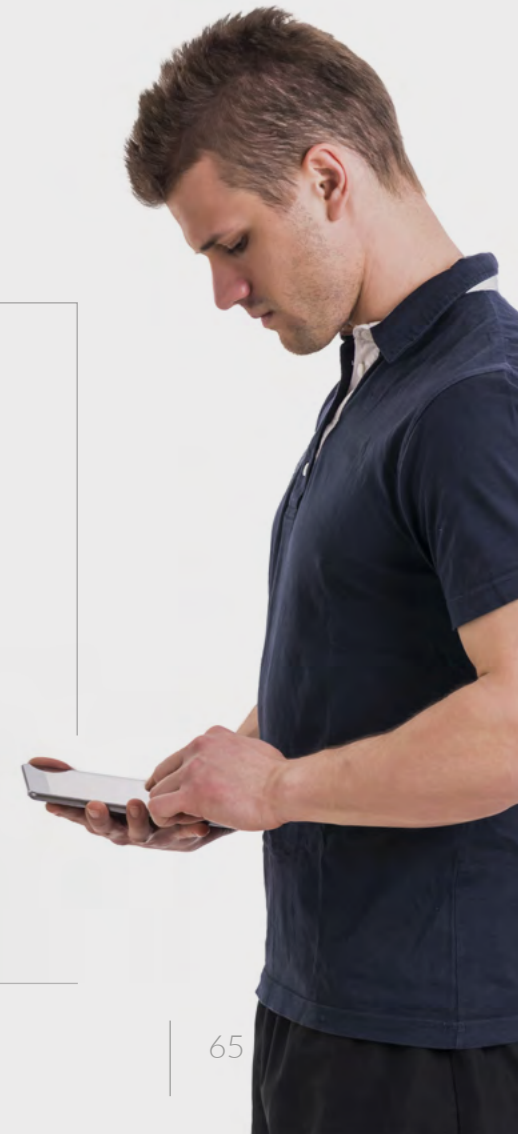
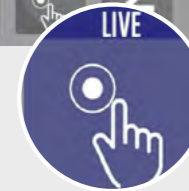

PROFESSIONAL USE

TOUCH STATION

CONTROL STATION WITH 7" TOUCH SCREEN AND A DEDICATED APP, TO CONTROL THE REAX BOARD. IT ALLOWS THE TRAINER TO CHOOSE THE MOST SUITABLE PROGRAM FOR EACH USER.



- SPECIAL APP INCLUDED
- PRE-SET PROGRAMS
- LIVE MODE CONTROL
- USER FRIENDLY INTERFACE



14 DIFFICULTY LEVELS

PRE-SET MODE AND PT MODE FOR MANUAL INTERFERENCE CONTROL

LOW LEVEL
1 - 2 - 3 - 4 - 5

MEDIUM LEVEL
6 - 7 - 8 - 9 - 10

HIGH LEVEL
11 - 12 - 13 - 14

PT MODE



LEADING THE GAME

THE EXCLUSIVE LIVE PROGRAM ALLOWS THE TRAINER TO REMOTELY CONTROL ALL THE DYNAMIC INTERFERENCES.

LIVE
M O D E

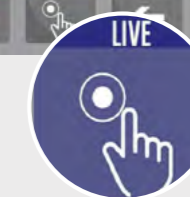

RE 1015

REAX BOARD 250

TECHNICAL SPECS



EQUIPMENT SPECIFICATIONS

AUTO STOP	YES
EMERGENCY STOP SYSTEM	YES
BLUETOOTH	YES
MOVEMENT	3D MOTION
MAXIMUM USER WEIGHT	150 KG 330 LB
STEP UP HEIGHT	33 CM 12,9921 IN
FRONTAL INCLINATION RANGE	+/- 11°
SIDE INCLINATION RANGE	+/- 14°
FRAME COLORS	GREY/BLACK
WIDTH OF USE	97 CM 38,19 IN
LENGTH OF USE	250 CM 98,43 IN

EQUIPMENT DIMENSION

WIDTH	134,5 CM 52,95 IN
LENGTH	251 CM 98,82 IN
HEIGHT	32 CM 12,60 IN

POWER REQUIREMENTS

INTERNATIONAL 240 VAC	YES
USA AND CANADA 110 VCA	YES
POWER CABLE LENGTH	1,5 M

REGULATORY

CE	YES
----	-----

RE 1016

REAX BOARD 125

TECHNICAL SPECS

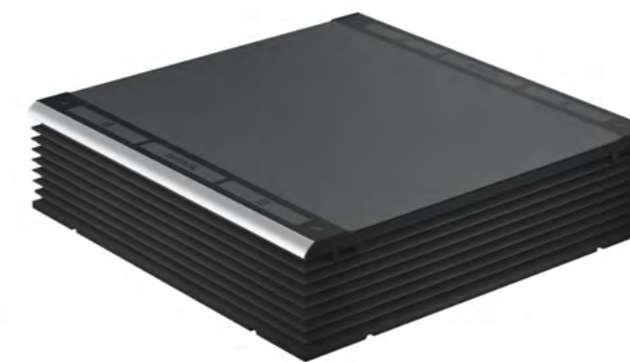

EQUIPMENT SPECIFICATIONS

AUTO STOP	YES
EMERGENCY STOP SYSTEM	YES
BLUETOOTH	YES
MOVEMENT	3D MOTION
MAXIMUM USER WEIGHT	150 KG 330 LB
STEP UP HEIGHT	33 CM 12,9921 IN
FRONTAL INCLINATION RANGE	+/- 11°
SIDE INCLINATION RANGE	+/- 14°
FRAME COLORS	GREY/BLACK
WIDTH OF USE	97 CM 38,19 IN
LENGTH OF USE	125 CM 49,21 IN

EQUIPMENT DIMENSION

WIDTH	134,5 CM 52,95 IN
LENGTH	126 CM 49,61 IN
HEIGHT	32 CM 12,60 IN

POWER REQUIREMENTS

INTERNATIONAL 240 VAC	YES
USA AND CANADA 110 VCA	YES
POWER CABLE LENGTH	1,5 M

REGULATORY

CE	YES
----	-----

REAX 1001

LIMITLESS STATION



ONE INFINITY ONE

FACE THE UNPREDICTABLE, AN EXCLUSIVE EXPERIENCE
WITH THE ONLY COGNITIVE, PROPRIOCEPTIVE AND NEU-
ROFUNCTIONAL TRAINING STATION IN THE WORLD.





THE FIRST AND ONLY NEUROREACTIVE PIECE OF EQUIPMENT IN THE WORLD THAT ALLOWS YOU TO PERFORM A COGNITIVE, PROPRIOCEPTIVE AND NEUROFUNCTIONAL TRAINING IN JUST 4 SQM. ALL ALL OUR INNOVATIVE AND PATENTED SOLUTIONS IN A SINGLE PROFESSIONAL STATION. ONE-INFINITY-ONE GRANTS UNLIMITED TRAINING COMBINATIONS. A SMART FLOOR AS THE REAX BOARD, A UNIQUE 3D TREADMILL AS THE REAX RUN, A MULTI-PURPOSE STATION FOR FUNCTIONAL TRAINING AND STORAGE PURPOSES, AND FINALLY AN INTELLIGENT LIGHTING SYSTEM AS THE REAX LIGHTS.

FASTER RESULTS FOR USERS

- > INCREASE OF REACTION RATE AND COORDINATION
- > IMPROVEMENT OF PERFORMANCE AND MOTOR SKILLS
- > GREATER MUSCLE ENGAGEMENT AND DEFINITION
- > Higher calories burn and metabolic activation
- > Better injury recover and functional re-education

BETTER RESULTS FOR PROFESSIONALS

- > PROFESSIONAL STANDING IMPROVEMENT
- > INCREASE THE CUSTOMERS ACQUISITION AND RETENTION
- > GREATER PROFIT MARGINS AND ADDITIONAL REVENUES
- > ADDED TRAINING VALUE TO A MULTIPLE CLIENTELE TARGET
- > EXCLUSIVITY AND INNOVATION OF THE SERVICES OFFERED



THE ONE AND ONLY NEUROREACTIVE STATION WITH
INFINITE EXERCISES IN **LESS THAN 4 SQM**

- CARDIO
- TONING
- COGNITIVE TRAINING
- PROPRIOCEPTIVE TRAINING
- NEUROFUNCTIONAL TRAINING



WHY IS IT SO INNOVATIVE?

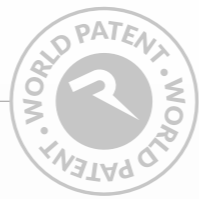

4-IN-1 TRAINING SOLUTIONS



PROPRIOCEPTIVE TREADMILL
The only treadmill that performs sudden and unpredictable inclinations in all directions while running.



PROPRIOCEPTIVE PLATFORM
The only training board adopting the **Sudden Dynamic Impulses** technology.



COGNITIVE LIGHTS SYSTEM
The lighting system that merges the cognitive and the reactive training.



FUNCTIONAL EQUIPMENT
A wide range of tools for the smartest trainers. Multi combinations to create a wide number of workouts.

WHY IS IT SO EFFECTIVE?

REAX 1001 AMPLIFIES THE EFFICIENCY OF EACH DIFFERENT EXERCISE.

Thanks to the **Sudden Dynamic Impulse** technology, it produces a greater neuro motor efficiency for a real and complete **Neuroreactive Training**, giving better results for health and performance.



NEUROFUNCTIONAL EQUIPMENT
WITH EXCLUSIVE TOOLS
FOR BOTH SIDES

CUSTOMIZABLE RACK
WITH MULTIPLE CONFIGURATIONS FOR STORAGE

PROPRIOCEPTIVE PLATFORM + TREADMILL
WITH 3D MOTION PATENTED TECHNOLOGY

WHY IS IT SO USEFUL FOR PERFORMANCE?

The products technology applied to a **Neuroreactive Training** enables a faster improvement in terms of physical fitness, reaction ability, execution speed and cognitive skills that are useful for performance purposes and in every different context of life.



- > WIDER RANGE OF EXERCISES AND INCREASEMENT OF THEIR EFFICIENCY
- > HIGH PROPRIOCEPTIVE STIMULATION AND POSTURAL ACTIVATION
- > HIGHER METABOLIC ACTIVATION AND ENERGY EXPENDITURE
- > WIDER INVOLVEMENT OF MUSCLE FIBRES
- > IMPROVED NEURAL EFFICIENCY AND TASK PROCESSING SKILLS
- > COORDINATION - BALANCE IMPROVEMENT AND FALLS PREVENTION
- > IMPROVEMENT IN MOTOR-GESTURE MANAGEMENT AND REACTIVITY
- > IMPROVING FUNCTIONAL RECOVERY

WINNING FEATURES



SPACE-SAVING

In 4sqm only you can find a treadmill, a smart proprioceptive floor and a multifunctional and cognitive station (pro-1 version)

UNIQUE

Features, figures and applications with no comparison

ORIGINAL

Innovation, elegance, ergonomic design and an advanced technology in a unique and stylish design

UNPREDICTABLE

Characterized by the Reaxing patented "Sudden Dynamic Impulse" technology

RELIABLE

Made it entirely in Europe with our well-known reputation in detail-care

SILENT

No noises for comfortable workouts, silent even at high speed or interference

USER-FRIENDLY

Easy software to use with an appealing simple-to-use interface

15" HIGH DEFINITION TOUCH SCREEN



On the large display you can watch exercise tutorials to manage your ideal workout, receiving all the information needed.

TOP QUALITY MATERIALS



The best materials and technology can be found in our Reax 1001. Every detail meets the highest quality standards.

DESIGNED FOR PROFESSIONALS



The marks on the training surface allow the user to have a better perception of the right starting position for the exercise.

BEST MOVEMENT EXPERIENCE



While running or walking, both the 72 cm wide belt and the shock absorbing system ensure the highest quality experience.

REAX 1001 PRO2

SPECIAL VERSION WITH CUSTOMIZABLE RACK AND WITH MULTIPLE CONFIGURATIONS FOR TRAINING AND STORAGE

FRAMEWORK

- MOBILE PLATFORM WITH TREADMILL AND MULTIFUNCTIONAL FACILITIES

FINISHES

- EMBOSSED BLACK MAT + SHINY BLACK + CHROMED SHINY BLACK DETAILS

CONSOLE

- 15" TOUCH SCREEN WITH 5 DEDICATED APPS
- OPTIONAL TABLET FOR REMOTE CONTROL

METHODS OF USE

- PROPRIOCEPTIVE REAX RUN
- PROPRIOCEPTIVE REAX BOARD
- NEUROFUNCTIONAL STATION
- REAX TIMER



CONFIGURATION EXAMPLES

REAX 1001 CAN COME IN MANY DIFFERENT CONFIGURATIONS TO PERFECTLY FIT YOUR NEEDS. A WIDE RANGE OF ACCESSORIES FOR TRAINING AND STORAGE PURPOSES ARE AVAILABLE.

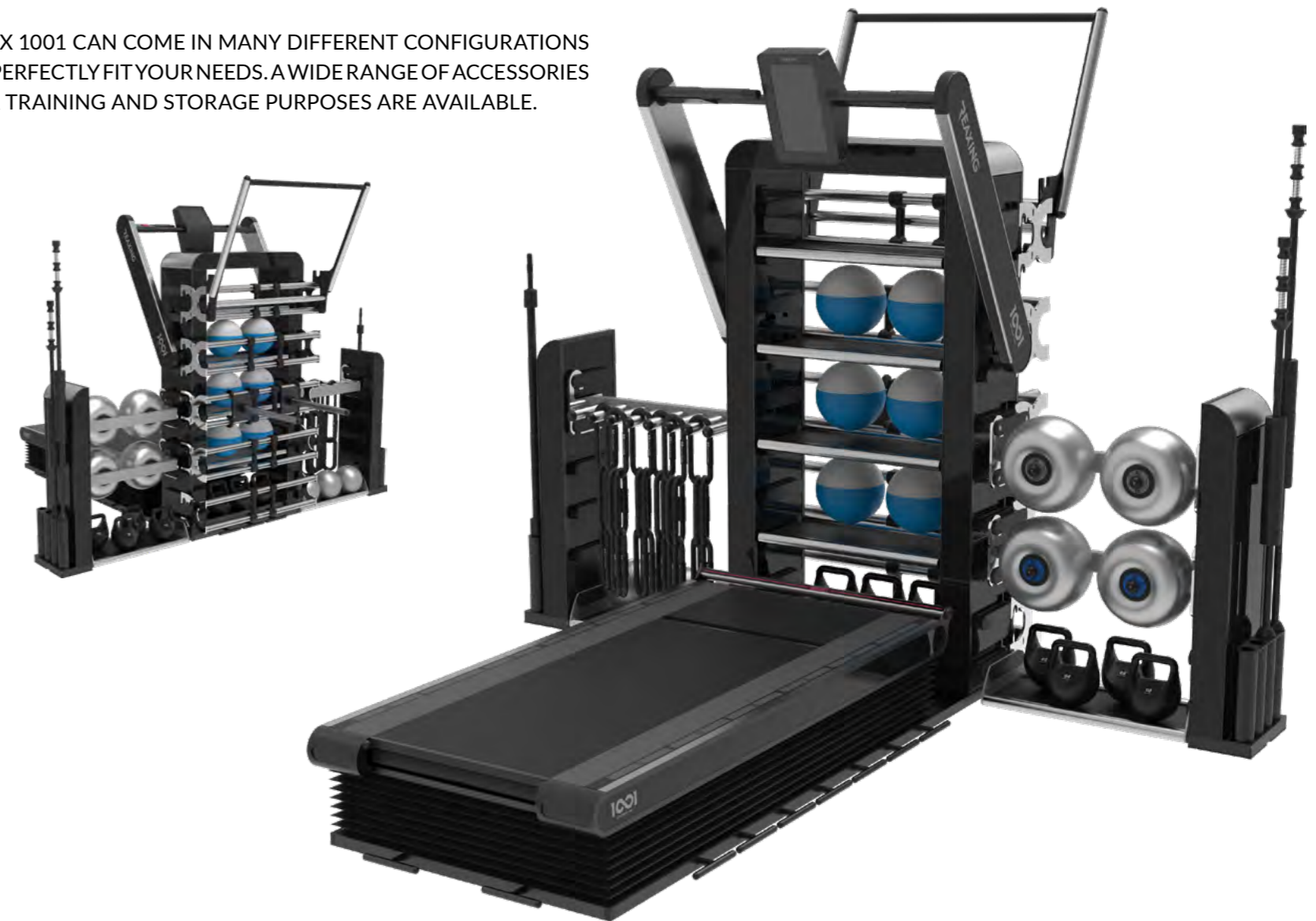

ENDLESS COMBINATIONS

A WIDE RANGE OF TOOLS AVAILABLE
TO ENRICH YOUR 1001 STATION

RE 5025 REAX LIGHTS PRO2 - ADVANCED 6



RE 1000 TABLET RE 1010 TABLET HOLDER



RE 1009 FLOOR FOR B SIDE

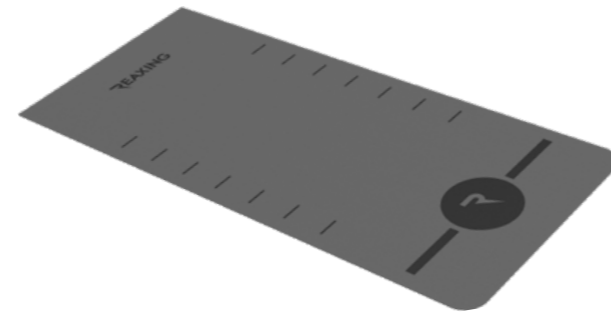

RE 1013 WALLBAR HOUSING / 3 PACK



RE 1004 1001 DOUBLE WALLBAR

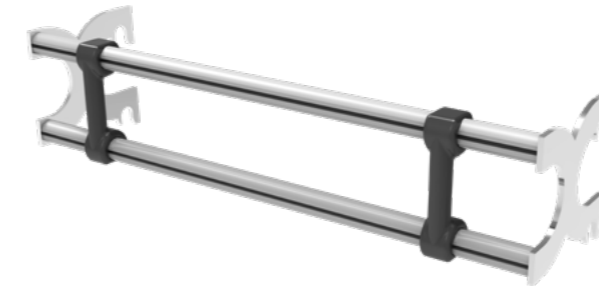

RE 1008 MULTIFUNCTIONAL SHELF 1

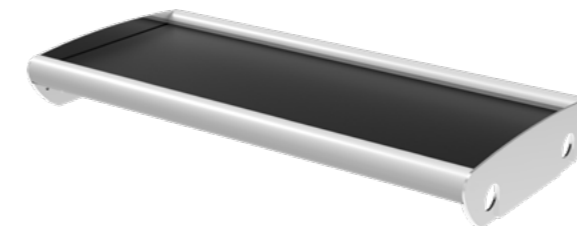

RE 1002 LATERAL STORAGES



RE 1005 MOBILE PARALLELS



RE 1006 MULTIFUNCTIONAL PULL UP



CHOOSE YOUR

REAX 1001

SOLUTION

- RE 1007 PURE 180
- RE 5007 EXECUTIVE 180
- RE 5008 FUNCTIONAL 180
- RE 5009 ADVANCE 180
- RE 5010 PREMIUM 180
- RE 5011 ADVANCE 360
- RE 5012 PREMIUM 360

RE 1007 REAX 1001 PRO2

PURE 180

1 RE 1007 REAX 1001 - PRO2

OPTIONAL

RE 1000 TABLET



RE 5007

REAX 1001 PRO2

EXECUTIVE 180

1 RE 1007
4 RE 1008

REAX 1001 - PRO2
MULTIFUNCTIONAL SHELF 1

OPTIONAL

RE 1000

TABLET



RE 5008

REAX 1001 PRO2

FUNCTIONAL 180

1 RE 1007
4 RE 1004
1 RE 1005
1 RE 1006

REAX 1001 - PRO2
1001 DOUBLE WALLBAR
MOBILE PARALLELS
MULTIFUNCTIONAL PULL UP

OPTIONAL

RE 1000
RE 1010
RE 5025
RE 1013
RE 1173
RE 1174

TABLET
TABLET HOLDER
REAX LIGHTS PRO2 - ADVANCED 6
WALLBAR HOUSING - 3 PACK
REAX APPAREL S/M
REAX APPAREL L/XL



RE 5009

REAX 1001 PRO2

ADVANCE 180

- 1 RE 1007
- 4 RE 1004
- 1 RE 1005
- 1 RE 1006
- 4 RE 1008

REAX 1001 - PRO2
 1001 DOUBLE WALLBAR
 MOBILE PARALLELS
 MULTIFUNCTIONAL PULL UP
 MULTIFUNCTIONAL SHELF 1

OPTIONAL

- RE 1000
- RE 1010
- RE 5025
- RE 1013
- RE 1173
- RE 1174

TABLET
 TABLET HOLDER
 REAX LIGHTS PRO2 - ADVANCED 6
 WALLBAR HOUSING - 3 PACK
 REAX APPAREL S/M
 REAX APPAREL L/XL



RE 5010

REAX 1001 PRO2

PREMIUM 180

- 1 RE 1007
- 4 RE 1004
- 1 RE 1005
- 1 RE 1006
- 4 RE 1008
- 1 RE 1002

REAX 1001 - PRO2
 1001 DOUBLE WALLBAR
 MOBILE PARALLELS
 MULTIFUNCTIONAL PULL UP
 MULTIFUNCTIONAL SHELF 1
 LATERAL STORAGES

OPTIONAL

- RE 1000
- RE 1010
- RE 5025
- RE 1013
- RE 1173
- RE 1174

TABLET
 TABLET HOLDER
 REAX LIGHTS PRO2 - ADVANCED 6
 WALLBAR HOUSING - 3 PACK
 REAX APPAREL S/M
 REAX APPAREL L/XL



RE 5011

REAX 1001 PRO2

ADVANCE 360

- 1 RE 1007
 - 5 RE 1004
 - 1 RE 1005
 - 1 RE 1006
 - 4 RE 1008
- REAX 1001 - PRO2
1001 DOUBLE WALLBAR
MOBILE PARALLELS
MULTIFUNCTIONAL PULL UP
MULTIFUNCTIONAL SHELF 1

OPTIONAL

- RE 1000
 - RE 1010
 - RE 5025
 - RE 1013
 - RE 1009
 - RE 1173
 - RE 1174
- TABLET
TABLET HOLDER
REAX LIGHTS PRO2 - ADVANCE 6
WALLBAR HOUSING - 3 PACK
FLOOR FOR B SIDE
REAX APPAREL S/M
REAX APPAREL L/XL



A SIDE

RE 5011

REAX 1001 PRO2

ADVANCE 360



B SIDE

RE 5012

REAX 1001 PRO2

PREMIUM 360

- 1 RE 1007
 - 5 RE 1004
 - 1 RE 1005
 - 1 RE 1006
 - 4 RE 1008
 - 1 RE 1002
- REAX 1001 - PRO2
1001 DOUBLE WALLBAR
MOBILE PARALLELS
MULTIFUNCTIONAL PULL UP
MULTIFUNCTIONAL SHELF 1
LATERAL STORAGES

OPTIONAL

- RE 1000
 - RE 1010
 - RE 5025
 - RE 1013
 - RE 1009
 - RE 1173
 - RE 1174
- TABLET
TABLET HOLDER
REAX LIGHTS PRO2 - ADVANCE 6
WALLBAR HOUSING - 3 PACK
FLOOR FOR B SIDE
REAX APPAREL S/M
REAX APPAREL L/XL



A SIDE

RE 5012

REAX 1001 PRO2

PREMIUM 360



B SIDE

SMART & INTUITIVE

THE MOST ADVANCED AND INTUITIVE TECHNOLOGY OFFER FOR TRAINING AND MONITORING PHYSICAL AND MENTAL PERFORMANCES, EXTENDING THE FIELD OF APPLICATION AND CREATING NEW AND MORE PROFITABLE BUSINESS AND PROFESSIONAL OPPORTUNITIES.



VARIOUS TRAINING PROGRAMS

QUICK START

MANUAL

TUTORIAL VIDEO

WARM UP

BALANCE

COORDINATION

FLEXIBILITY

AGILITY

STRENGTH

FAT LOSS

GOAL DISTANCE

GOAL TIME

GOAL CALORIE

DOWN HILL

UP HILL

HIKING

FARTLEK

HIIT

TRIAL

CHR

CADENCE

PACE

REMOTE & LIVE CONTROL

REAX TABLET

AN OPTIONAL TABLET INTEGRATED WITH A DEDICATED APP ALLOWS THE USER TO PROGRAM AND CONTROL EACH PHASE OF THE WORKOUT. IT IS ALSO POSSIBLE FOR THE TRAINER TO GIVE AND MODIFY THE IMPULSES DURING THE EXERCISE.



LEADING THE GAME

LIVE

M O D E

THE SPECIAL LIVE PROGRAM (AVAILABLE ONLY ON TABLET) ALLOWS THE TRAINER TO KEEP CONTROL OF THE INTERFERENCES.

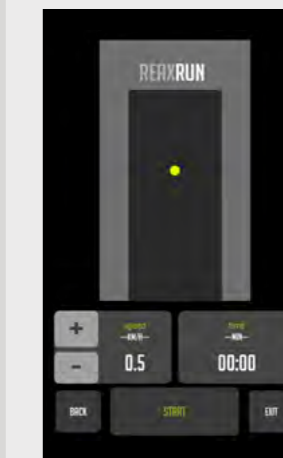

PRO2 INTERFACES

4 DIFFERENT POSSIBILITIES OF USE, SELECTABLE FROM THE CONSOLE HOMEPAGE: REAX RUN FOR RUNNING, REAX BOARD FOR BODYWEIGHT EXERCISES, REAX FUNCTIONAL FOR NEUROMUSCULAR TRAINING AND REAX TIMER TO BETTER MANAGE YOUR WORKOUTS.

Home

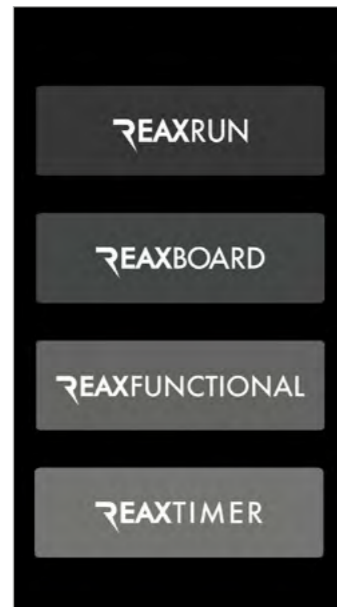

Reax Board

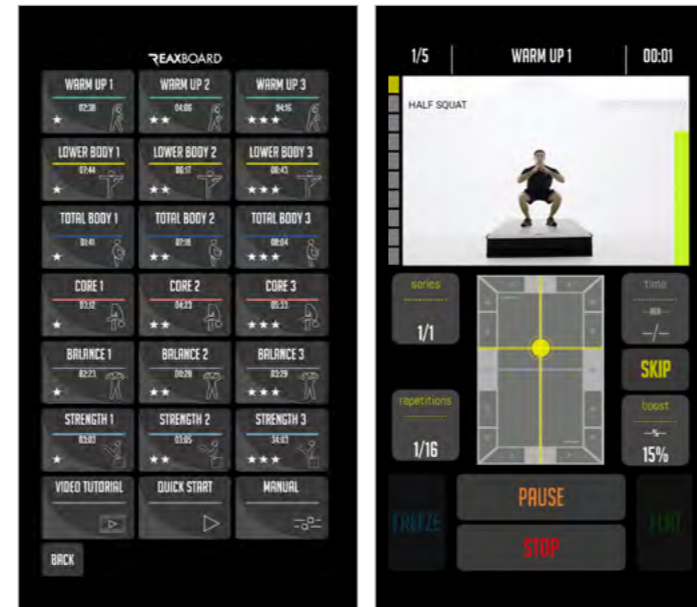

Reax Run



Reax Timer

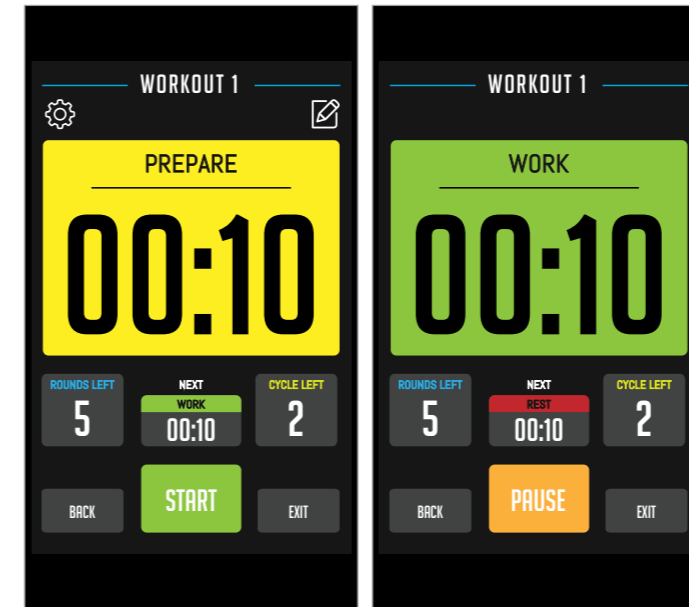

Reax Functional

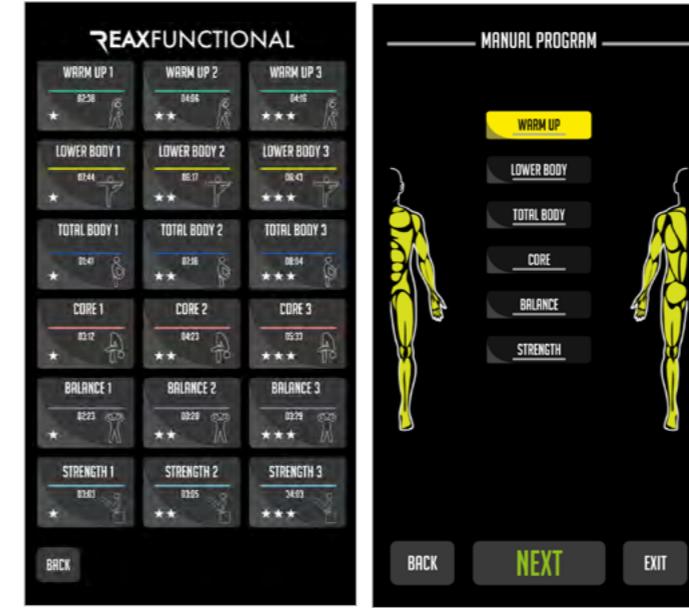

LIGHTING SYSTEM

OPTIONAL

REAX 1001 PRO2 VERSION CAN BE EQUIPPED WITH THE REAX LIGHTS PRO SYSTEM CONTROLLED BY A DEDICATED REAX TABLET.



AREA SET-UP

ONE-INFINITY-ONE IS VERSATILE AND CAN FIT IN ANY SPACE, CREATING NEUROREACTIVE TRAINING AREAS WHERE USERS CAN PERFORM A SAFE AND EFFECTIVE WORKOUT.

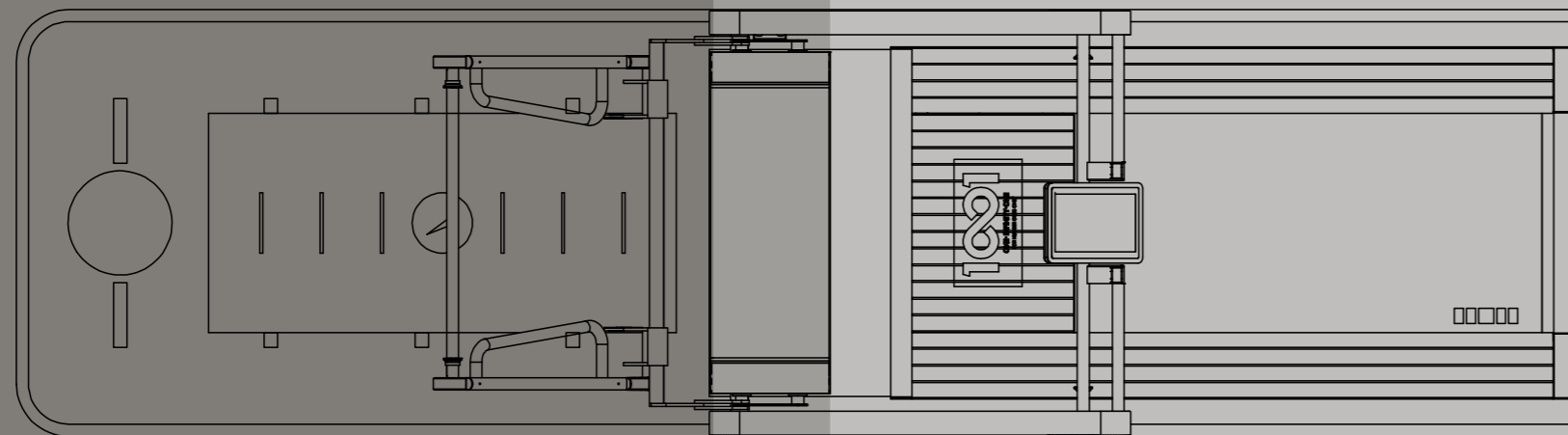

180° SPACE

WALL MOUNTED

TO TRAIN UP TO 5 PEOPLE
IN THE SAME TIME

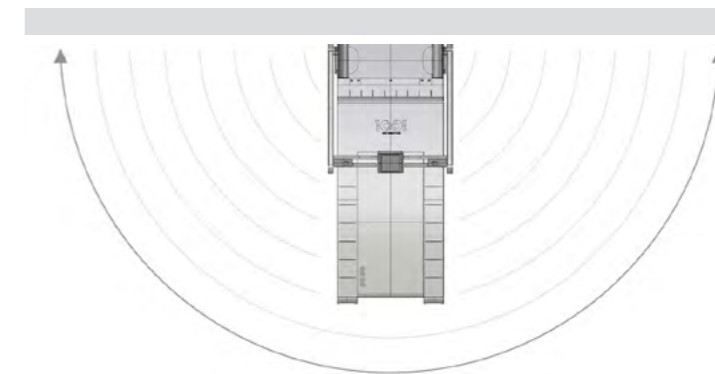

360° SPACE

NO WALL MOUNTED

TO TRAIN UP TO 8 PEOPLE
IN THE SAME TIME



180° SOLUTIONS

MINIMUM
PRODUCT
SPACE **3,4 SQM**

WALL MOUNTED (15 cm)
FRONTAL position:
• A side use for training



180° SOLUTIONS

MINIMUM
PRODUCT
SPACE **4,2 SQM**

NEAR THE WALL (70 cm)
FRONTAL position:
• A side use for training
• B side use for storage
LATERAL position:
• A side use for training
• B side use for training / storage

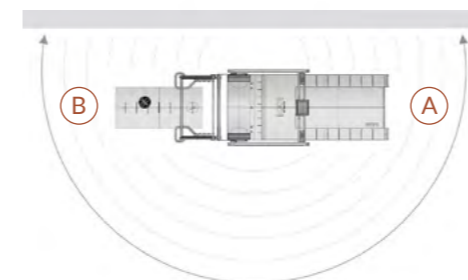
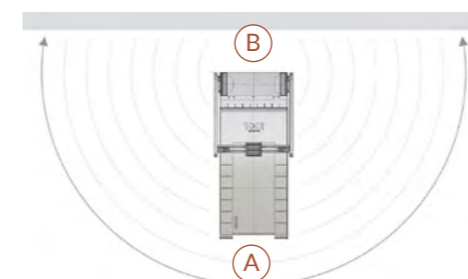

360° SOLUTIONS

MINIMUM
PRODUCT
SPACE **5,7 SQM**

NO WALL MOUNTED
1 OR 2 PEOPLE

- A side use for training
- B side use for training / storage



360° SOLUTIONS

MINIMUM
PRODUCT
SPACE FROM **16 SQM**

NO WALL MOUNTED
1 OR 2 PEOPLE

- A side use for training
- B side use for training / storage
- C side use for training / storage
- D side use for training / storage

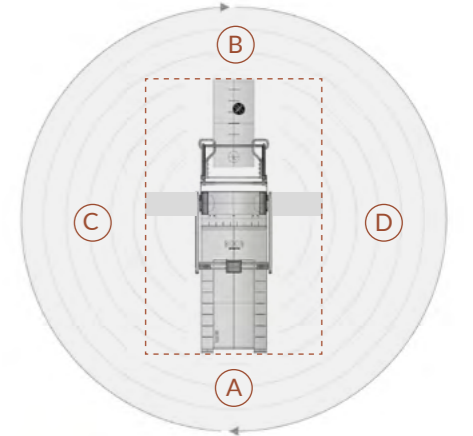



RE 1002

REAX 1001 PRO2

TECHNICAL SPECS

EQUIPMENT SPECIFICATIONS

AUTO STOP	YES
EMERGENCY STOP SYSTEM	YES
ELEVATION SYSTEM	NO
PATENTED MOVEMENT	3D MOTION
BLUETOOTH	NO
HANDLEBAR LENGTH OF USE	48 CM 18,89 IN
ARM ROTATION SYSTEM	YES
ROLLER DIAMETER	12 CM 4,72 IN
MOTOR	2,2 3 HP
MAXIMUM USER WEIGHT	220 KG 485 LB
STEP UP HEIGHT	38 CM 14,96 IN
SPEED RANGE	0,5-25 KM/H
FRONTAL INCLINATION RANGE	+/- 11°
SIDE INCLINATION RANGE	+/- 14°
FRAME COLOR	BLACK
RUNNING SURFACE WIDTH	73 CM 28,74 IN
LIGHTS STATION SYSTEM	NO
MONITOR SIZE	15" LCD - WIDE 16:9

DIMENSION AND WEIGHT

WIDTH	136 CM 53,54 IN
LENGTH	287 CM 112,99 IN
HEIGHT	256 CM 100,78 IN

POWER REQUIREMENTS

INTERNATIONAL 240 VAC	YES
USA AND CANADA 110 VCA	110V-220V
	TRANSFORMER REQUIRED
POWER CABLE LENGTH	200 CM 78,74 IN

REGULATORY

CE	YES
----	-----

CONSOLE FEATURES

CONSOLE TYPE	TOUCH SCREEN
OPERATING SYSTEM	ANDROID
QUICKSTART	YES
CONSOLE LANGUAGE (S)	ENGLISH, RUSSIAN
NUMBER OF PROGRAMS	4

HEART RATE MONITORING

TELEMETRY	POLAR H7, H10, POLAR T31 (NOT CODED)
-----------	--

REAX LIGHTS PRO

THE CLEVER LIGHTS





REAX LIGHTS

TEST YOUR SKILLS AND IMPROVE THEM DAY BY DAY WITH THE WORLD'S MOST ADVANCED TRAINING SYSTEM. A PATENTED TECHNOLOGY TO IMPROVE MOTOR SKILLS, COGNITION, PERIPHERAL VISION & REACTIVITY.



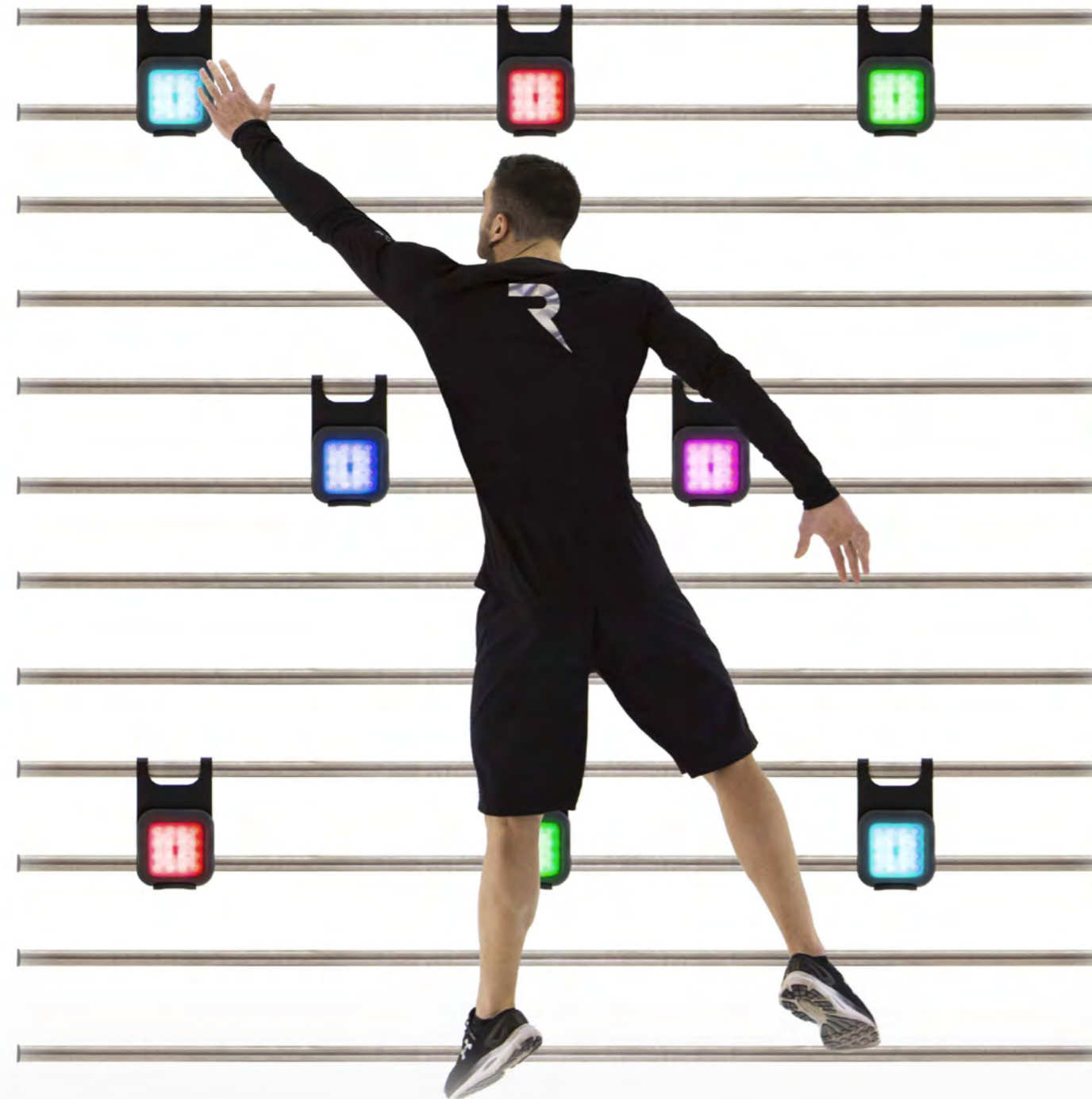

REAX LIGHTS PRO IS AN INTELLIGENT AND PATENTED SYSTEM, UNIQUE FOR ITS VERSATILITY AND USER-FRIENDLY. AN INTEGRATED CONCEPT DESIGNED TO DEVELOP INTERACTIVE TRAINING PROGRAMMES, COMBINATIONS OF TASKS AND REFLEXES IMPROVEMENT. THE REAX LIGHTS SYSTEM IS THE ONLY ONE THAT INCLUDES MOBILE SATELLITES, WALLS AND FLOORS, AS WELL AS A COMPLETE RANGE OF ACCESSORIES FOR AN INNOVATIVE COGNITIVE TRAINING.

FASTER RESULTS FOR USERS

- > INCREASE OF REACTION RATE AND COORDINATION
- > IMPROVEMENT OF PERFORMANCE AND MOTOR SKILLS
- > GREATER MUSCLE ENGAGEMENT AND DEFINITION
- > HIGHER CALORIES BURN AND METABOLIC ACTIVATION
- > BETTER INJURY RECOVER AND FUNCTIONAL RE-EDUCATION

BETTER RESULTS FOR PROFESSIONALS

- > PROFESSIONAL STANDING IMPROVEMENT
- > INCREASE THE CUSTOMERS ACQUISITION AND RETENTION
- > GREATER PROFIT MARGINS AND ADDITIONAL REVENUES
- > ADDED TRAINING VALUE TO A MULTIPLE CLIENTELE TARGET
- > EXCLUSIVITY AND INNOVATION OF THE SERVICES OFFERED

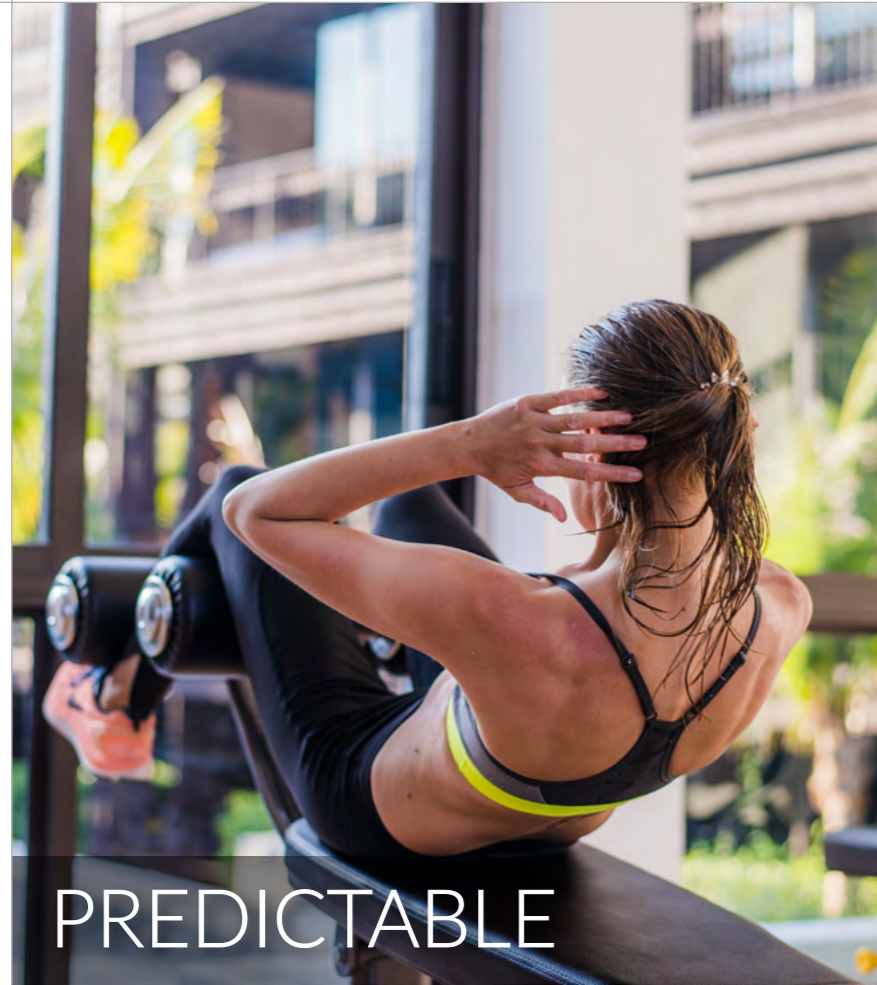

PREDICTABLE

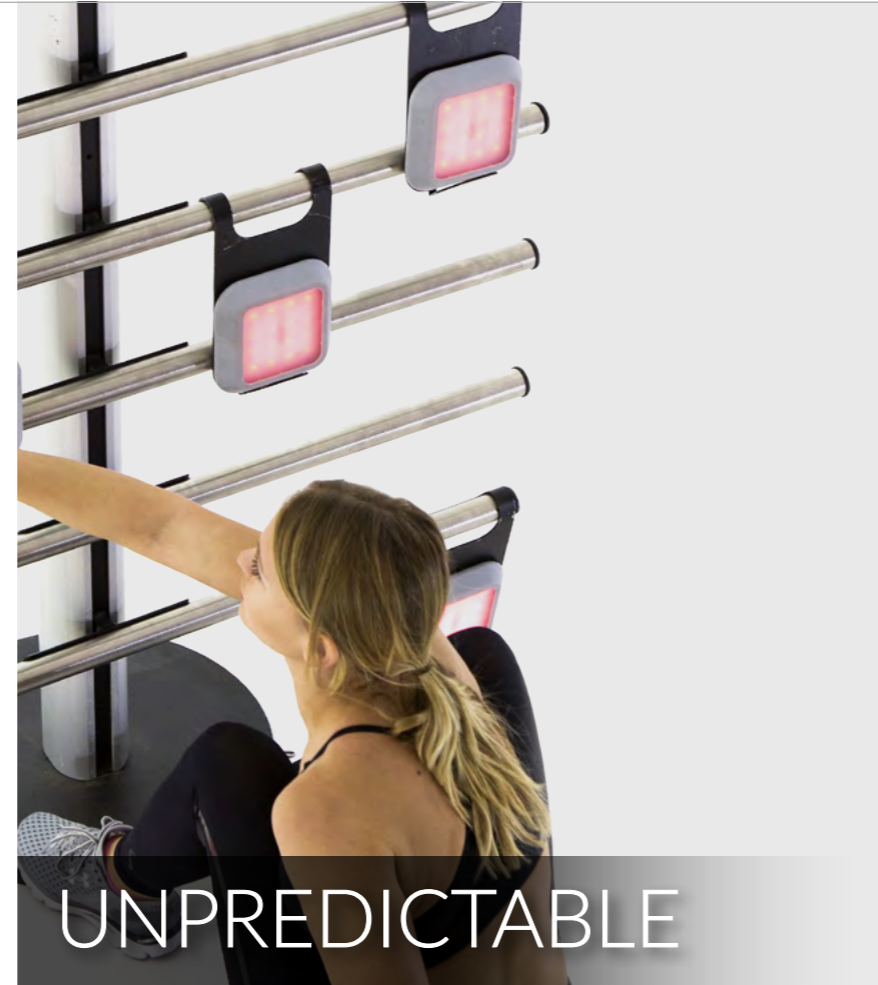

UNPREDICTABLE

A new vision based on the everyday and sports needs:
the ability to react to changing and unexpected situations.



WHY ARE THEY SO

INNOVATIVE?

The construction of a visual stimulation training and its translation into motor gestures has always been considered an elite field. Thanks to our Reax Lights this opportunity is now reachable by all the professionals in the industry.



ENLARGE AND AMPLIFY YOUR
VISION FIELD

INCREASE AND SPEED UP YOUR
BRAIN PROCESSING

STIMULE AND IMPROVE YOUR
MOTOR GESTURE



3D VISION

FROM STIMULI TO ACTIVATION, FROM ACTION TO REACTION, CUT DOWN THE TIME AND TURN A GESTURE INTO AN AUTOMATISM

FOCUS & MOTIVATION

REAX LIGHTS PRO is an indispensable tool to train an athlete to always maintain high mental focus and to increase motivation during the exercise and during daily activities.



REACTIVITY & SPEED

REAX LIGHTS PRO is designed to improve reactivity and speed during performances. The continuous stimuli sent to the neuro-motor system facilitate the automatism implementation while training.



AGILITY & COORDINATION

REAX LIGHTS PRO allows you to improve the dynamic competence during the motor gestures by coordinating and stimulating rhythm, responsiveness, speed and many other motor skills.





WHY ARE THEY SO EFFECTIVE?

SUDDEN AND DYNAMIC VISUAL
STIMULATION, APPLIED FOR
MOTOR PURPOSES.

- > IMPROVING PERIPHERAL VISION
- > IMPROVING TASK PROCESSING SKILLS
- > IMPROVEMENT IN MOTOR-GESTURE
MANAGEMENT
- > IMPROVING THE REACTIVITY
- > IMPROVING THE COORDINATION
- > IMPROVING POST-ACCIDENT
FUNCTIONAL RECOVERY
- > SUPPORT IN NEURODEGENERATIVE
DISEASES TREATMENT

WHY ARE THEY SO USEFUL FOR PERFORMANCE?

Better results are reached thanks to a very strong stimulation of the
visual apparatus and to a higher involvement of the nervous system
in the elaboration of complex motor tasks linked to the various colors.



WINNING FEATURES



UNIQUE

The only mobile lights satellite system which is able to create 3D cognitive training spaces. Two technologies available: Wi-Fi and Bluetooth

ORIGINAL

Italian design, made in Italy and worldwide patented.

RELIABLE

Attention to the details and built with the best materials. Rubber case shockproof. Pressure-resistant slide.

USER FRIENDLY

Intuitive use thanks to a plug and play app (no preset needed).

FUNCTIONAL

Proximity sensors able to react even without touching the satellite. Database to save training sessions. Downloadable and/or sharable data.

MAGNETIC SYSTEM



SHOCK ABSORBING



ERGONOMIC SHAPE



USER FRIENDLY

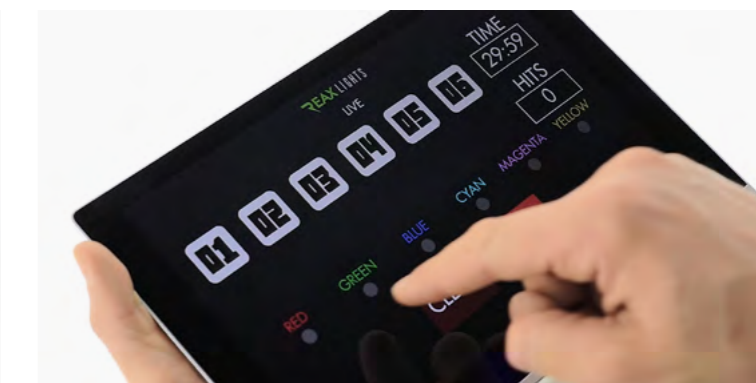

RE 1020

REAX LIGHTS

PRO1

models

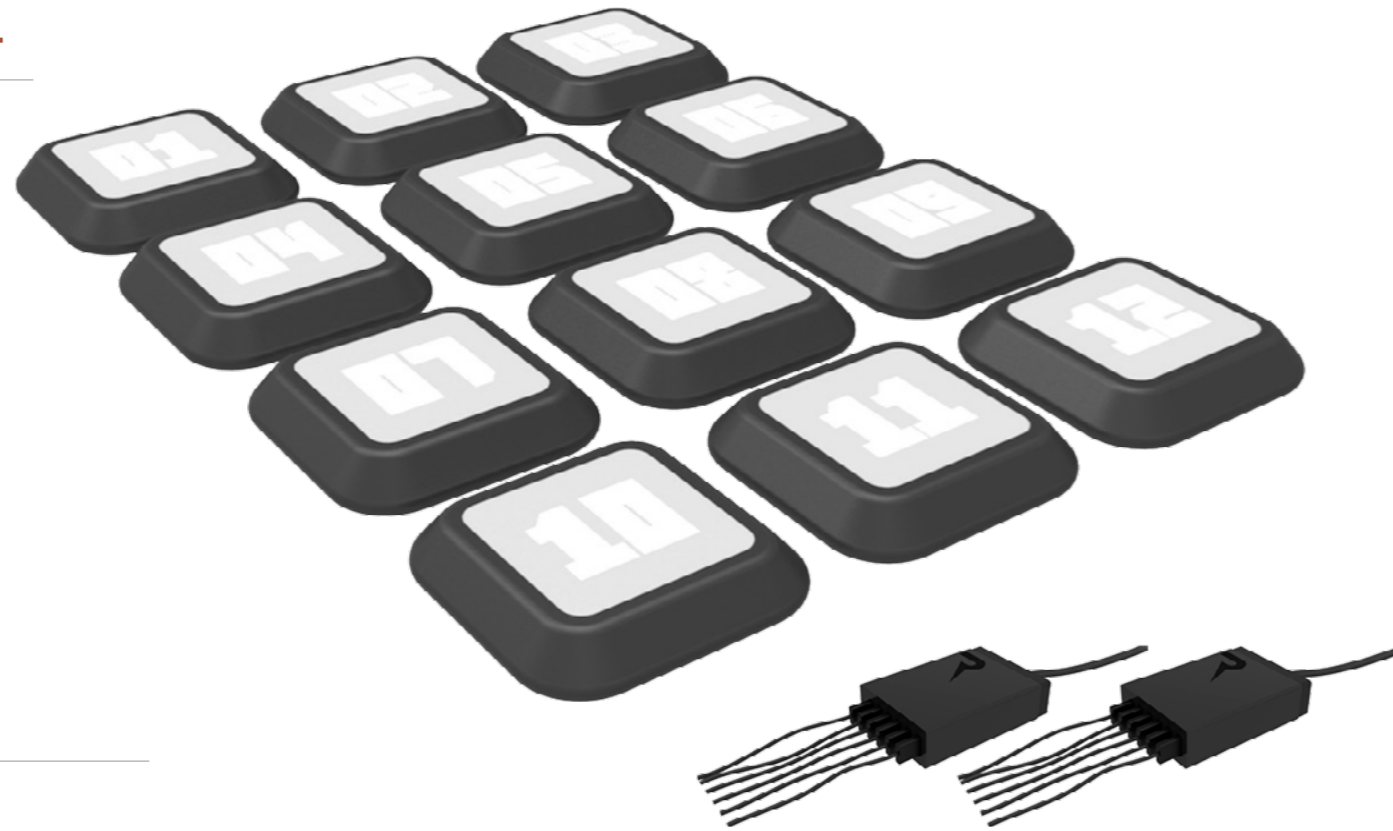

- 12 SATELLITES
- 6 LIGHT COLORS
- INDUCTION CHARGING

WIFI

RE 1169

REAX LIGHTS

PRO2

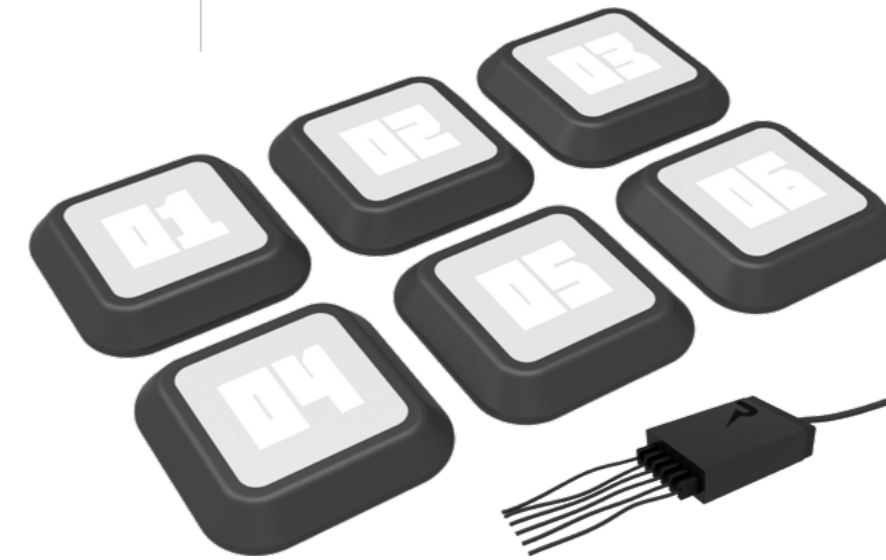

- 6 SATELLITES
- 6 LIGHT COLORS
- INDUCTION CHARGING

WIFI

RE 1147

REAX LIGHTS

PRO3



- 4 SATELLITES
- 6 LIGHT COLORS
- CABLE CHARGING

BLUETOOTH

TRAINING WALLS

RE 1021 PREMIUM STATION



RE 1027 IRON PANEL



RE 1032 WALLBAR



WALLS ACCESSORIES

- RE 1038 FLOOR FOR STATION
- RE 1039 FLOOR FOR PANEL
- RE 1066 LATERAL RACK FOR PREMIUM STATION

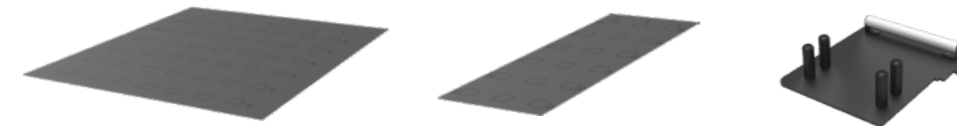

POLE KIT

- RE 1024 POLE KIT 200 - 3 PACK
- RE 1025 POLE KIT 100 - 2 PACK
- RE 1037 JUNCTION POLE



CHARGER

- RE 1026 INDUCTION CHARGER WITH TOUCH FOR REAX LIGHTS - PRO1
- RE 1028 INDUCTION CHARGER WITH TABLET HOLDER FOR REAX LIGHTS - PRO1
- RE 1030 INDUCTION CHARGER WITH TABLET HOLDER FOR REAX LIGHTS - PRO2



TRAVEL KIT

- RE 1029 WIRELESS WI-FI ROUTER (TRAVEL BAG INCLUDED)



TRAINING ACCESSORIES

- RE 1005 MOBILE PARALLELS
- RE 1006 MULTIFUNCTIONAL PULL UP
- RE 1022 MULTIFUNCTIONAL BARS
- RE 1023 PULL UP



SATELLITE HOUSING

- RE 1034 SUCTION CUP - 3 PACK
- RE 1163 SUCTION CUP - 1 PC
- RE 1035 STRAP - 3 PACK
- RE 1164 STRAP - 1 PC
- RE 1036 COLLAR - 3 PACK
- RE 1165 COLLAR - 1 PC
- RE 1040 BAND FOR BOXING BAG
- RE 1013 WALLBAR HOUSING - 3 PACK



CHOOSE YOUR
LIGHTS
SYSTEM

SOLUTION

RE 5018	PRO1 PREMIUM STATION
RE 5019	PRO1 ADVANCE PANEL
RE 5020	PRO1 STARTER PARE
RE 5021	PRO2 WALLBARRE
RE 5022	PRO1 STARTER 12
RE 5023	PRO2 STARTER 6
RE 1147	PRO3 STARTER 4



RE 5018

REAX LIGHTS PRO1

PREMIUM STATION

- 1 RE 1020
- 1 RE 1021
- 1 RE 1005
- 1 RE 1023
- 1 RE 1022
- 1 RE 1024
- 1 RE 1025
- 1 RE 1066

REAX LIGHTS - PRO1 - 12 SATELLITES
 PREMIUM STATION
 MOBILE PARALLELS
 PULL UP
 REAX MULTIFUNCTIONAL BARS
 POLE KIT 200 - 3 PACK
 POLE KIT 100 - 2 PACK
 LATERAL RACK FOR PREMIUM STATION

OPTIONAL

- RE 1034 SATELLITE HOUSING SUCTION CUP - 3 PACK
- RE 1035 SATELLITE HOUSING STRAP - 3 PACK
- RE 1036 SATELLITE HOUSING COLLAR - 3 PACK
- RE 1037 JUNCTION POLE
- RE 1038 FLOOR FOR STATION RE 1000 TABLET
- RE 1029 WIRELESS WIFI ROUTER (TRAVEL BAG INCLUDED)
- RE 1173 REAX APPAREL S/M RE 1174 APPAREL L/XL



RE 5019

REAX LIGHTS PRO1

ADVANCE PANEL

- 1 RE 1020
- 1 RE 1026
- 2 RE 1027
- 1 RE 1024
- 1 RE 1025

REAX LIGHTS - PRO1 - 12 SATELLITES
 INDUCTION CHARGER WITH TOUCH FOR REAX LIGHTS - PRO1
 IRON PANEL
 POLE KIT 200 - 3 PACK
 POLE KIT 100 - 2 PACK

OPTIONAL

- RE 1034 SATELLITE HOUSING SUCTION CUP - 3 PACK
- RE 1035 SATELLITE HOUSING STRAP - 3 PACK
- RE 1036 SATELLITE HOUSING COLLAR - 3 PACK
- RE 1037 JUNCTION POLE
- RE 1039 FLOOR FOR PANEL RE 1000 TABLET
- RE 1029 WIRELESS WIFI ROUTER (TRAVEL BAG INCLUDED)
- RE 1173 REAX APPAREL S/M RE 1174 APPAREL L/XL



RE 5020

REAX LIGHTS PRO1

STARTER PANEL

OPTIONAL

- RE 1034 SATELLITE HOUSING SUCTION CUP - 3 PACK
- RE 1035 SATELLITE HOUSING STRAP - 3 PACK
- RE 1036 SATELLITE HOUSING COLLAR - 3 PACK
- RE 1037 JUNCTION POLE
- RE 1039 FLOOR FOR PANEL
- RE 1173 REAX APPAREL S/M
- RE 1174 REAX APPAREL L/XL

- 1 RE 5024 REAX LIGHTS - PRO1 - ADVANCED 12
- 1 RE 1000 TABLET
- 1 RE 1028 INDUCTION CHARGER WITH TABLET HOLDER FOR REAX LIGHTS - PRO1
- 2 RE 1027 IRON PANEL
- 1 RE 1024 POLE KIT 200 - 3 PACK
- 1 RE 1025 POLE KIT 100 - 2 PACK

RE 5021

REAX LIGHTS PRO2

WALLBAR

OPTIONAL

- RE 1034 SATELLITE HOUSING SUCTION CUP - 3 PACK
- RE 1035 SATELLITE HOUSING STRAP - 3 PACK
- RE 1036 SATELLITE HOUSING COLLAR - 3 PACK
- RE 1037 JUNCTION POLE
- RE 1173 REAX APPAREL S/M
- RE 1174 REAX APPAREL L/XL

- 1 RE 5025 REAX LIGHTS - PRO2 - ADVANCE 6
- 1 RE 1000 TABLET
- 1 RE 1030 INDUCTION CHARGER WITH TABLET HOLDER FOR REAX LIGHTS - PRO2
- 1 RE 1032 WALLBAR
- 1 RE 1005 MOBILE PARALLELS
- 1 RE 1006 MULTIFUNCTIONAL PULL UP
- 2 RE 1013 WALLBAR HOUSING - 3 PACK
- 1 RE 1024 POLE KIT 200 - 3 PACK
- 1 RE 1025 POLE KIT 100 - 2 PACK

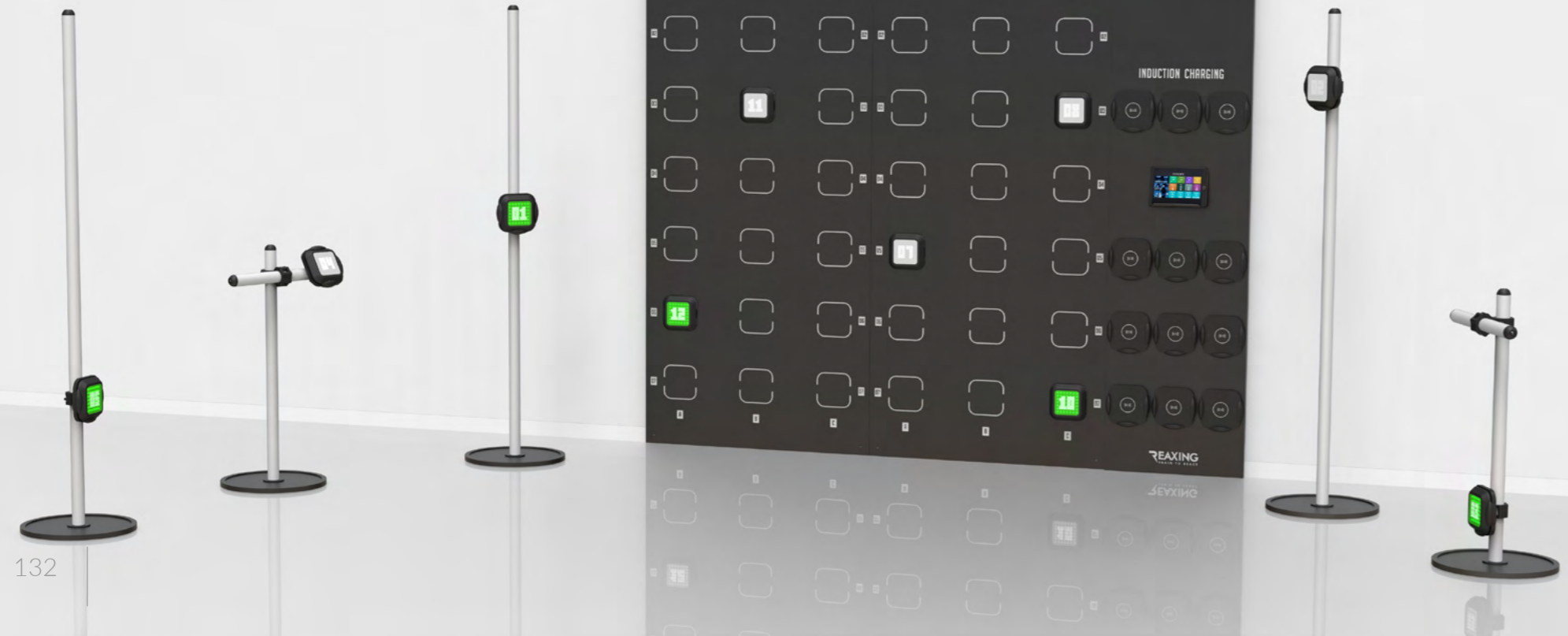

RE 5022

REAX LIGHTS PRO1

STARTER 12

1 RE 5024
1 RE 1000

REAX LIGHTS - PRO1 - ADVANCED 12
TABLET

OPTIONAL

- RE 1034 SATELLITE HOUSING SUCTION CUP - 3 PACK
- RE 1035 SATELLITE HOUSING STRAP - 3 PACK
- RE 1040 SATELLITE HOUSING BAND FOR BOXING BAG
- RE 1173 REAX APPAREL S/M
- RE 1174 REAX APPAREL L/XL



RE 5023

REAX LIGHTS PRO2

STARTER 6

1 RE 1025
1 RE 1000

REAX LIGHTS - PRO2 - ADVANCE 6
TABLET

OPTIONAL

- RE 1034 SATELLITE HOUSING SUCTION CUP - 3 PACK
- RE 1035 SATELLITE HOUSING STRAP - 3 PACK
- RE 1040 SATELLITE HOUSING BAND FOR BOXING BAG
- RE 1173 REAX APPAREL S/M
- RE 1174 REAX APPAREL L/XL



STARTER 4 OPTIONAL

- RE 1163 SATELLITE HOUSING SUCTION CUP - 1 PC
- RE 1164 SATELLITE HOUSING STRAP - 1 PC
- RE 1165 SATELLITE HOUSING COLLAR - 1 PC
- RE 1000 TABLET

RE 1147

REAX LIGHTS PRO3

STARTER 4

1 RE 1147

REAX LIGHTS - PRO3 STARTER 4



CONTROL SYSTEMS

THE REAX LIGHTS APP IS ADAPTABLE TO ANY NEED: IT HAS BEEN DESIGNED TO OFFER A UNIQUE TRAINING AND TO MANAGE THE CUSTOMER/ATHLETE EXPERIENCE.

- DEDICATED AND UPDATABLE APP
- INTUITIVE AND USER-FRIENDLY INTERFACE
- PROGRAMS READY FOR USE
- TESTING AREA AND CUSTOMIZABLE PROGRAMS



TRAINING PROGRAMS

REACT 1/2/3/4/5

Programs dedicated to improving reflexes

FIX 1/2

Programs to add cardio elements to cognitive purposes

CIRCUIT

To manage small groups or involve users in time circuits

MOBILE

The most versatile of our programs, great for dozens of uses

COMBAT

For exciting challenges between two contenders

LIVE

Totally open program to give space to the imagination of the trainer

GROUP

4 different options to involve groups of people in the same exercise simultaneously

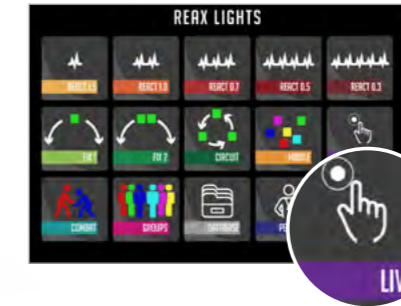

LEADING THE GAME

A SPECIAL LIVE PROGRAM ALLOWS THE TRAINER TO TAKE CONTROL OF THE SATELLITES, MODIFYING THE LIGHTS SEQUENCE AND SPEED DURING THE EXERCISE.

LIVE

M O D E



REAX LIGHTS PRO1 / PRO2

TECHNICAL SPECS

EQUIPMENT SPECIFICATIONS

N ° SATELLITES	12/6
WIFI	YES
BLUETOOTH	NO
COVER COLOR	BLACK
WORKING RANGE (Ø)	5000 CM 1968,5 IN
LIGHT COLOR	RED, GREEN, BLUE, YELLOW, CYAN, MAGENTA
TIME OF USE (ESTIMATED)	8 H
LIFE EXPECTANCY (>80%)	500 CYCLES
INDUCTION CHARGING	YES
CHARGING WITH CABLE	YES
POWER ON SOUND SIGNAL	YES
BATTERY STATUS LEVEL	YES (AT STARTUP)
BATTERY CHARGER WITH CABLE	YES
IR SENSOR	YES
ROUTER	YES

EQUIPMENT DIMENSION AND WEIGHT

WIDTH	16,5 CM 6,49 IN
LENGTH	16,5 CM 6,49 IN
HEIGHT	3,5 CM 1,37 IN
SINGLE SATELLITE WEIGHT	0,6 KG 1 LB

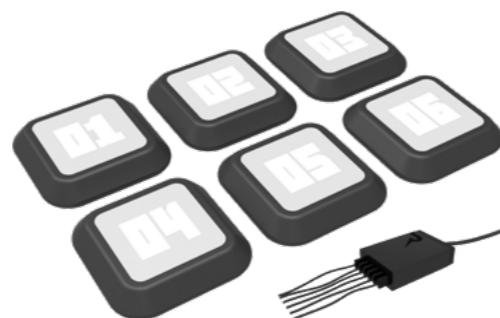
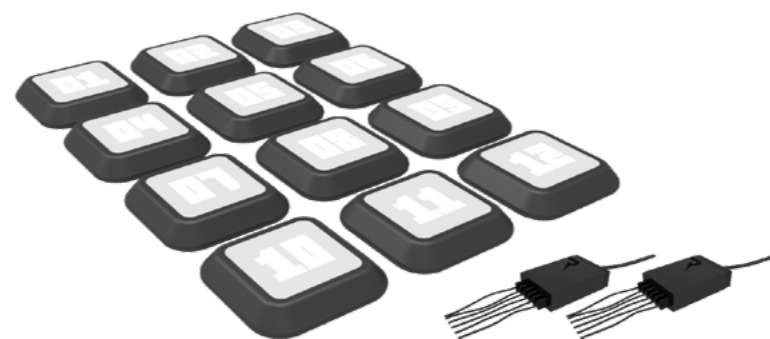

POWER REQUIREMENTS

INTERNATIONAL 240 VAC	YES
USA AND CANADA 110 VCA	YES

REGULATORY

CE	YES
----	-----

REAX LIGHTS PRO3

TECHNICAL SPECS

EQUIPMENT SPECIFICATIONS

N ° SATELLITES	4
WIFI	NO
BLUETOOTH	YES
COVER COLOR	BLACK
WORKING RANGE (Ø)	1000 CM 393,7 IN
LIGHT COLOR	RED, GREEN, BLUE, YELLOW, CYAN, MAGENTA
TIME OF USE (ESTIMATED)	8 H
LIFE EXPECTANCY (>80%)	500 CYCLES
INDUCTION CHARGING	NO
CHARGING WITH CABLE	YES
POWER ON SOUND SIGNAL	YES
BATTERY STATUS LEVEL	YES (AT STARTUP)
BATTERY CHARGER WITH CABLE	YES
IR SENSOR	YES
ROUTER	NO

EQUIPMENT DIMENSION AND WEIGHT

WIDTH	16,5 CM 6,49 IN
LENGTH	16,5 CM 6,49 IN
HEIGHT	3,5 CM 1,37 IN
SINGLE SATELLITE WEIGHT	0,6 KG 1 LB



POWER REQUIREMENTS

INTERNATIONAL 240 VAC	YES
USA AND CANADA 110 VCA	YES

REGULATORY

CE	YES
----	-----

REAX LIFT

THE UNPREDICTABLE LOAD



REAX LIFT

THE ONLY SOFT-SHOCK BARBELL THAT ALLOWS
SAFE TRAININGS WITH AN UNSTABLE LOAD.

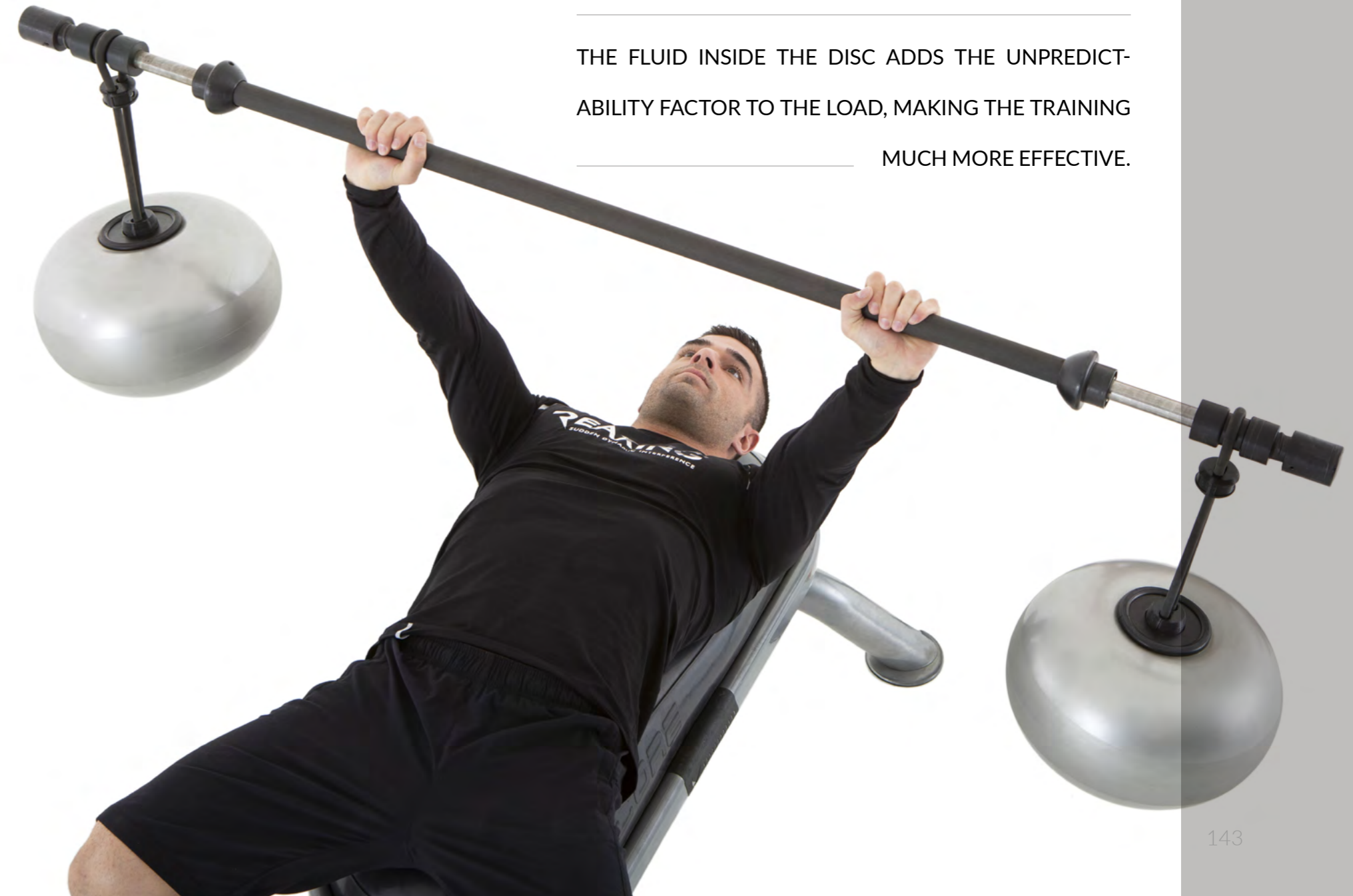

THE FLUID INSIDE THE DISC ADDS THE UNPREDICT-
ABILITY FACTOR TO THE LOAD, MAKING THE TRAINING
MUCH MORE EFFECTIVE.



REAX LIFT IS THE FIRST BARBELL IN THE WORLD THAT DESTABILIZES THE MOVEMENT PATTERNS AND INCREASES THE MOTOR RESPONSE. THIS FEATURE INVOLVES A WIDE RANGE OF MUSCLE FIBRES AS THE USER NEEDS BOTH TO LIFT AND STABILIZE THE WEIGHT AT THE SAME TIME. THUS, THE USER WILL GET BETTER RESULTS USING LESS WEIGHT: AN EXCELLENT SOLUTION TO IMPROVE STRENGTH LOWERING THE JOINT STRESS.

FASTER RESULTS FOR USERS

- > INCREASE OF REACTION RATE AND COORDINATION
- > IMPROVEMENT OF PERFORMANCE AND MOTOR SKILLS
- > GREATER MUSCLE ENGAGEMENT AND DEFINITION
- > HIGHER CALORIES BURN AND METABOLIC ACTIVATION
- > BETTER INJURY RECOVER AND FUNCTIONAL RE-EDUCATION

BETTER RESULTS FOR PROFESSIONALS

- > PROFESSIONAL STANDING IMPROVEMENT
- > INCREASE THE CUSTOMERS ACQUISITION AND RETENTION
- > GREATER PROFIT MARGINS AND ADDITIONAL REVENUES
- > ADDED TRAINING VALUE TO A MULTIPLE CLIENTELE TARGET
- > EXCLUSIVITY AND INNOVATION OF THE SERVICES OFFERED

VARIABLE STIMULI

FROM PREDICTABLE TO UNPREDICTABLE



LIFTING AN UNSTABLE WEIGHT REQUIRES CONTINUOUS NEUROMUSCULAR ADAPTATION WITH HIGH PROPRIOCEPTIVE ACTIVATION.

A traditional disc is inert so it only responds to gravity. REAX LIFT has an unstable fluid inside, which increases the dynamic movement during the lift. This stimulation increases the effort of the user in order to balance and control the weight. A double effort is required: overcoming the gravity and stabilizing the load.



REAX LIFT OFFERS NEW MOVEMENT PERSPECTIVES THANKS TO THE INTERFERENCES PRODUCED BY THE 3D WAVE TECHNOLOGY.

An ordinary weight-lifting exercise requires a linear and constant effort. Using our elastic accessories the motor interference can increase up to very complex movements.

MULTIDIRECTIONAL OSCILLATIONS

FROM TRADITIONAL TO INNOVATIVE



SILENT, SOFT AND SAFE



THE LIFT DISCS SOLVE THE DANGEROUSNESS ISSUE OF THE TRADITIONAL DISCS.

THANKS TO THE PARTICULAR TECHNOLOGY THEY ARE MADE OF, THEY RESULT SILENT, SOFT AND SAFE.



> SILENT

> SOFT

> SAFE

LET THE REAX LIFT FALL! YOU WILL NOTICE THAT NOT LOUD NOISE OR VIBRATION WILL BE GENERATED. IT IS THE PERFECT SOLUTION FOR UPPER FLOORS USES.

THE SPECIAL ELASTIC POLYMER MAKES THE DISC NON-DEFORMABLE AND RESISTANT TO ALL THE CLASSIC STRESSES OF A BARBELL, AS LONG AS THEY ARE USED ON SMOOTH SURFACES.

IT DOES NOT DAMAGE SURFACES. THE SOFT STRUCTURE OF THE DISC AND THE LINING OF THE BARBELL MAKE THE REAX LIFT SAFER FOR USERS, PREVENTING THE RISK OF ACCIDENTAL INJURIES DERIVED BY HYPOTETICAL IMPACTS.



innovation

WHY IS IT SO

INNOVATIVE?

IT IS THE FIRST WEIGHT TRAINING SYSTEM THAT INTERACTS WITH THE USER DUE TO ITS UNSTABLE LOAD.



Thanks to its innovative system, the Reax Lift can be used in both traditional and unconventional ways, improving the training efficiency. Compared to a traditional disc, using the same load, it is possible to notice a much higher neuromuscular commitment.

UNSTABLE
CHALLENGING
SAFE



3D WAVE

REAX LIFT SYSTEM INCLUDES FLUID-FILLED DISCS, SPRINGS FOR HORIZONTAL OSCILLATIONS AND ELASTIC ACCESSORIES FOR VERTICAL, TRANSVERSAL AND REBOUND OSCILLATIONS.

WAVE IMPULSE FLUID INSIDE

The fluid contained in the Reax disc generates unpredictable wave impulses. The fluid moves in all directions destabilizing the tool.

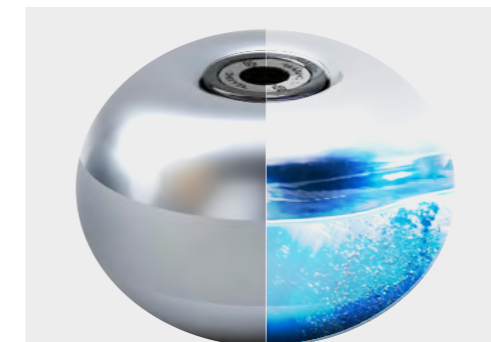

REBOUND MOVE BUNGEE TOOL

Reax Lift offers, using a bungee tool, an additional rebound effect that increases the difficulty level of the exercise.



SILENT-SOFT-SAFE ELASTIC STRUCTURE

The high resistance and elastic structure of the polymer make the Reax Disc durable and non-deformable providing also a silent, soft and safe use.



WINNING FEATURES

THE UNSTABLE LOAD INVOLVES PROPRIOCEPTIVE ABILITIES WITHOUT COMPARISON:

- > Increases the overall strength level
- > Increases the load control ability
- > Better abilities in dealing with sudden external dynamic interferences
- > Increases core-strength
- > Improves the ability to maintain balance
- > Increases the capacity to deal with potential harmful events

THESE FEATURES ALLOW US TO BE EFFICIENT AND HIGH PERFORMING IN SPORTS BUT FOREMOST IN EVERY DAY LIFE.

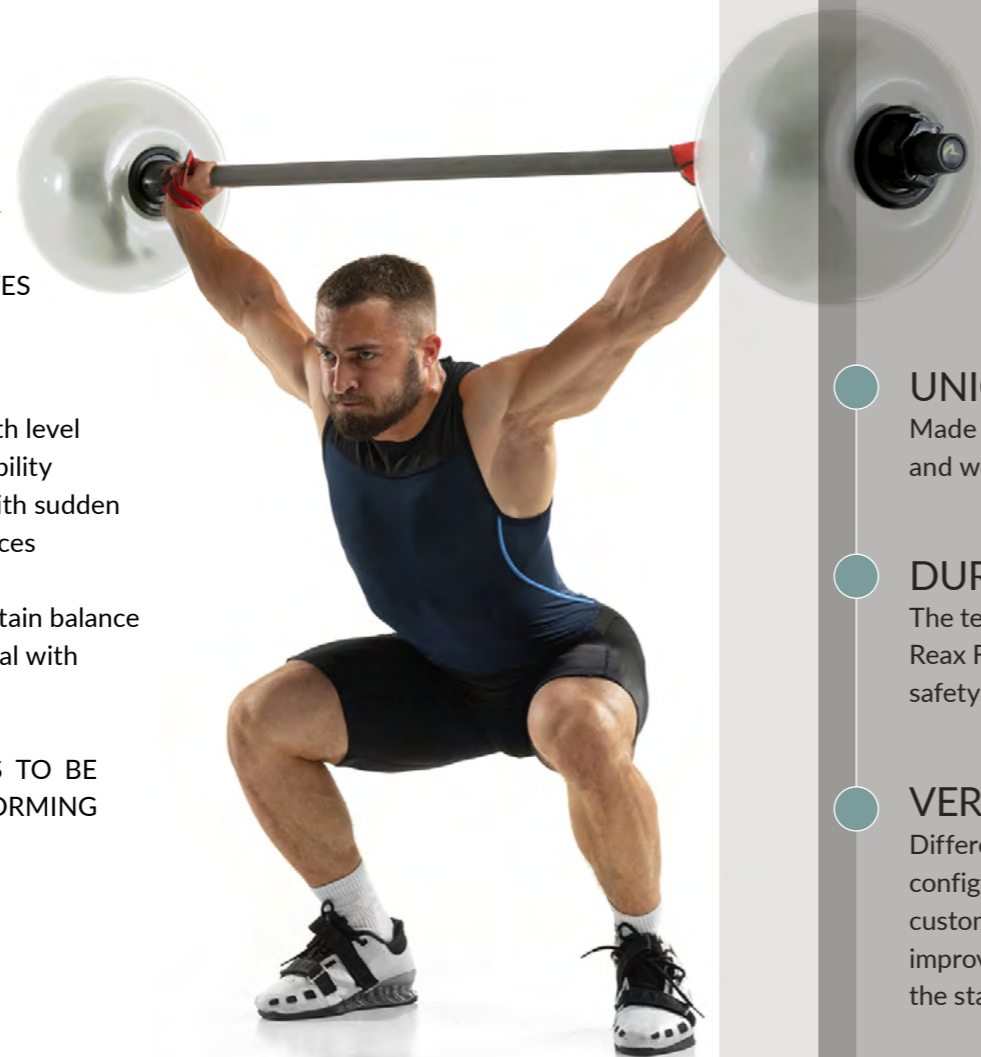

UNIQUE

Made in Europe and worldwide patent

DURABLE

The technology used to create the Reax Fluilift ensures its durability, safety and ease of cleaning.

VERSATILE

Different weights and configurations allow the user to customize their training programs, improving any workout beyond the standard products.

REAX LIFT ALLOWS TO PERFORM ALL THE CLASSIC BARBELL EXERCISES WITH MANY VARIABLE ELEMENTS.



BAR

ELASTIC

DISK

MULTIPLE CONFIGURATIONS

The REAX LIFT disc system can also be used on standard Olympic barbells and on any bar with a 50 mm diameter.



REAX DISK +
REAX BAR



REAX DISK +
REAX BUNGEE +
REAX BAR

EXPLORING
REAX LIFT
SYSTEM



DISCOVER THE REAX LIFT, THE
WIDE RANGE OF TRAINING &
STORAGE ACCESSORIES



REAX RACK PRO1

RE1041



LENGTH	CM IN	159,00 62,60
HEIGHT	CM IN	250,00 98,43
WIDTH	CM IN	181,00 71,26

REAX BENCH

RE1042



LENGTH	CM IN	153,00 60,24
HEIGHT	CM IN	65,00 25,60
WIDTH	CM IN	150,00 59,06

REAX DISCS

- RE1049 - 5 KG
- RE1050 - 7,5 KG
- RE1051 - 10 KG
- RE1052 - 15 KG
- RE1053 - 20 KG
- RE1054 - 25 KG



REAX BUNGEE

- RE1055 FOR 5 KG
- RE1056 FOR 7,5 KG
- RE1057 FOR 10 KG



REAX BAR

- RE1062 OLYMPIC BAR - 220
- RE1058 REAX BAR - 200
- RE1240 OLYMPIC BAR - 200
- RE1069 BAR COLLARS
- RE1068 CUSHION

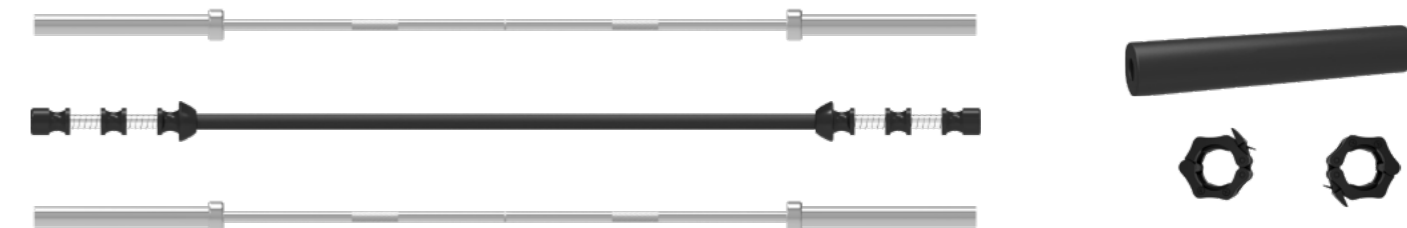

REAX RACK TOOLS

- RE1070 REAX DISK HOLDER
- RE1005 MOBILE PARALLELS



REAX STORAGE

- RE1059 VERTICAL STORAGE 1
- RE1060 VERTICAL STORAGE 2

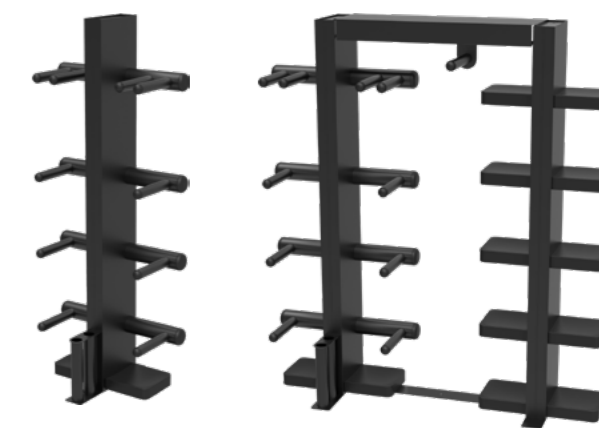

CHOOSE YOUR

LIFT

SYSTEM

SOLUTION

RE5029	PRO1 PREMIUM
RE5030	PRO2 PREMIUM
RE5026	PRO1 KIT
RE5027	PRO2 KIT



RE5029

REAX LIFT

PRO1 PREMIUM

- 1 RE1041
- 1 RE1042
- 6 RE1070
- 1 RE1049
- 1 RE1050
- 1 RE1051
- 1 RE1052
- 1 RE1053
- 1 RE1054
- 1 RE1055
- 1 RE1056
- 1 RE1057
- 2 RE1058

REAX RACK - PRO1
 REAX BENCH
 REAX DISK HOLDER
 LIFT DISCS - 5 KG
 LIFT DISCS - 7,5 KG
 LIFT DISCS - 10 KG
 LIFT DISCS - 15 KG
 LIFT DISCS - 20 KG
 LIFT DISCS - 25 KG
 BUNGEE FOR 5 KG
 BUNGEE FOR 7,5 KG
 BUNGEE FOR 10 KG
 REAX BAR 200

OPTIONAL

- RE1068
- RE1069
- RE1240
- RE1062
- RE1005
- RE1059
- RE1060

CUSHION
 BAR COLLARS
 OLYMPIC BAR - 200
 OLYMPIC BAR - 220
 MOBILE PARALLELS
 VERTICAL STORAGE 1
 VERTICAL STORAGE 2



RE5030

REAX LIFT

PRO2 PREMIUM

- 1 RE1041
- 1 RE1042
- 1 RE1049
- 1 RE1050
- 1 RE1051
- 1 RE1055
- 1 RE1056
- 1 RE1057
- 1 RE1058

REAX RACK - PRO1
 REAX BENCH
 LIFT DISCS - 5 KG
 LIFT DISCS - 7,5 KG
 LIFT DISCS - 10 KG
 BUNGEE FOR 5 KG
 BUNGEE FOR 7,5 KG
 BUNGEE FOR 10 KG
 REAX BAR 200

OPTIONAL

- RE1068
- RE1069
- RE1240
- RE1062
- RE1005
- RE1059
- RE1060

CUSHION
 BAR COLLARS
 OLYMPIC BAR - 200
 OLYMPIC BAR - 220
 MOBILE PARALLELS
 VERTICAL STORAGE 1
 VERTICAL STORAGE 2



RE5026

REAX LIFT

PRO1 KIT



- 1 RE1049
- 1 RE1050
- 1 RE1051
- 1 RE1052
- 1 RE1053
- 1 RE1054
- 1 RE1055
- 1 RE1056
- 1 RE1057
- 2 RE1058

LIFT DISCS - 5 KG
 LIFT DISCS - 7,5 KG
 LIFT DISCS - 10 KG
 LIFT DISCS - 15 KG
 LIFT DISCS - 20 KG
 LIFT DISCS - 25 KG
 BUNGEE FOR 5 KG
 BUNGEE FOR 7,5 KG
 BUNGEE FOR 10 KG
 REAX BAR 200

OPTIONAL



- RE1068
- RE1069
- RE1240
- RE1062
- RE1059
- RE1060

CUSHION
 BAR COLLARS
 OLYMPIC BAR - 200
 OLYMPIC BAR - 220
 VERTICAL STORAGE 1
 VERTICAL STORAGE 2

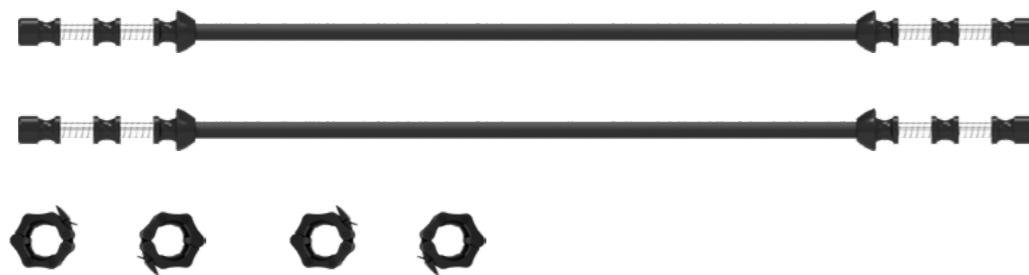

RE5027

REAX LIFT

PRO2 KIT



- 1 RE1049
- 1 RE1050
- 1 RE1051
- 1 RE1055
- 1 RE1056
- 1 RE1057
- 1 RE1058

LIFT DISCS - 5 KG
 LIFT DISCS - 7,5 KG
 LIFT DISCS - 10 KG
 BUNGEE FOR 5 KG
 BUNGEE FOR 7,5 KG
 BUNGEE FOR 10 KG
 REAX BAR 200

OPTIONAL



- RE1068
- RE1069
- RE1240
- RE1062
- RE1059
- RE1060

CUSHION
 BAR COLLARS
 OLYMPIC BAR - 200
 OLYMPIC BAR - 220
 VERTICAL STORAGE 1
 VERTICAL STORAGE 2



REAX 3D MAT

THE SENSORY FLOOR

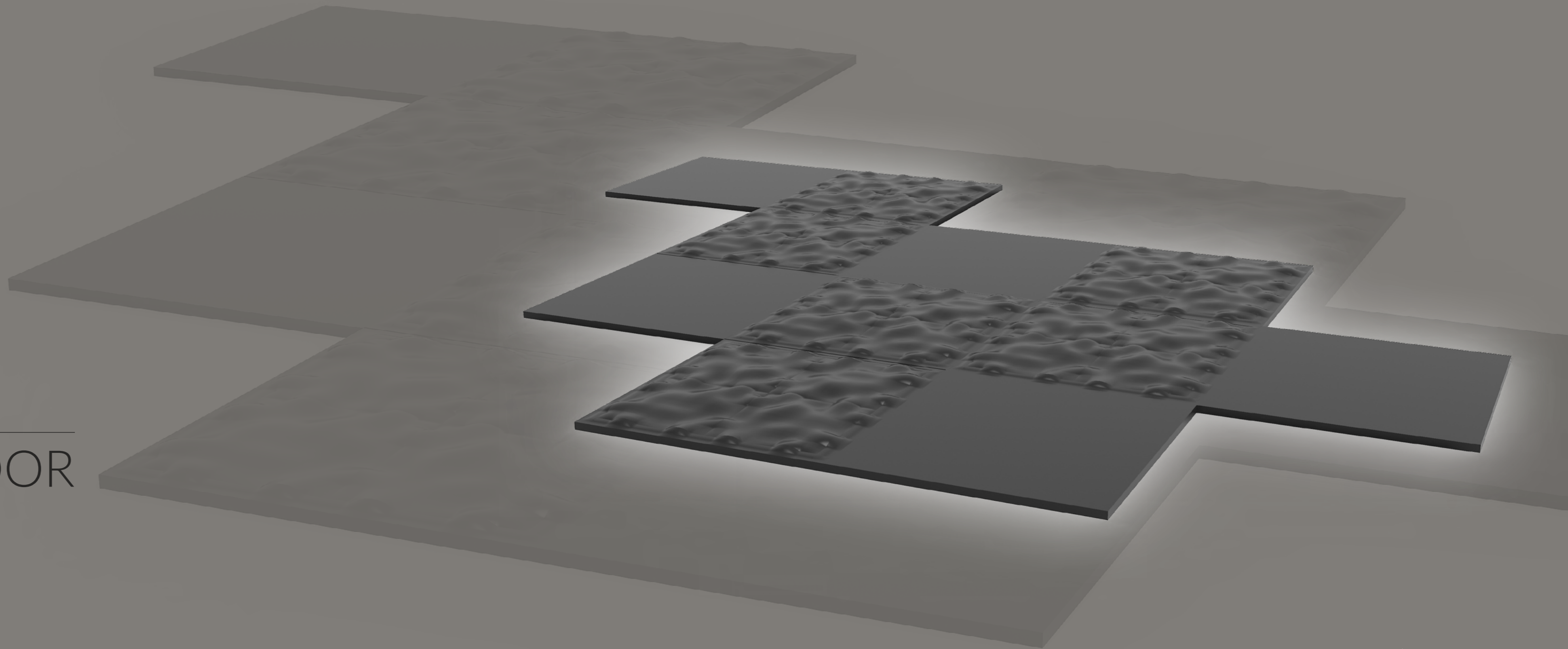



REAX 3D MAT

WITH THIS FLOOR YOU CAN IMPROVE YOUR TRAINING RESULTS BY STIMULATING THE PROPRIOCEPTIVE REFLEX AND DEVELOPING DAY BY DAY THE DYNAMIC MOTOR SKILLS.



MODULAR FLOOR

THE MODULARITY OF 3D MAT ALLOWS TO CREATE SENSORY SURFACES OF ANY SIZE AND WITH DIFFERENT TEXTURES.

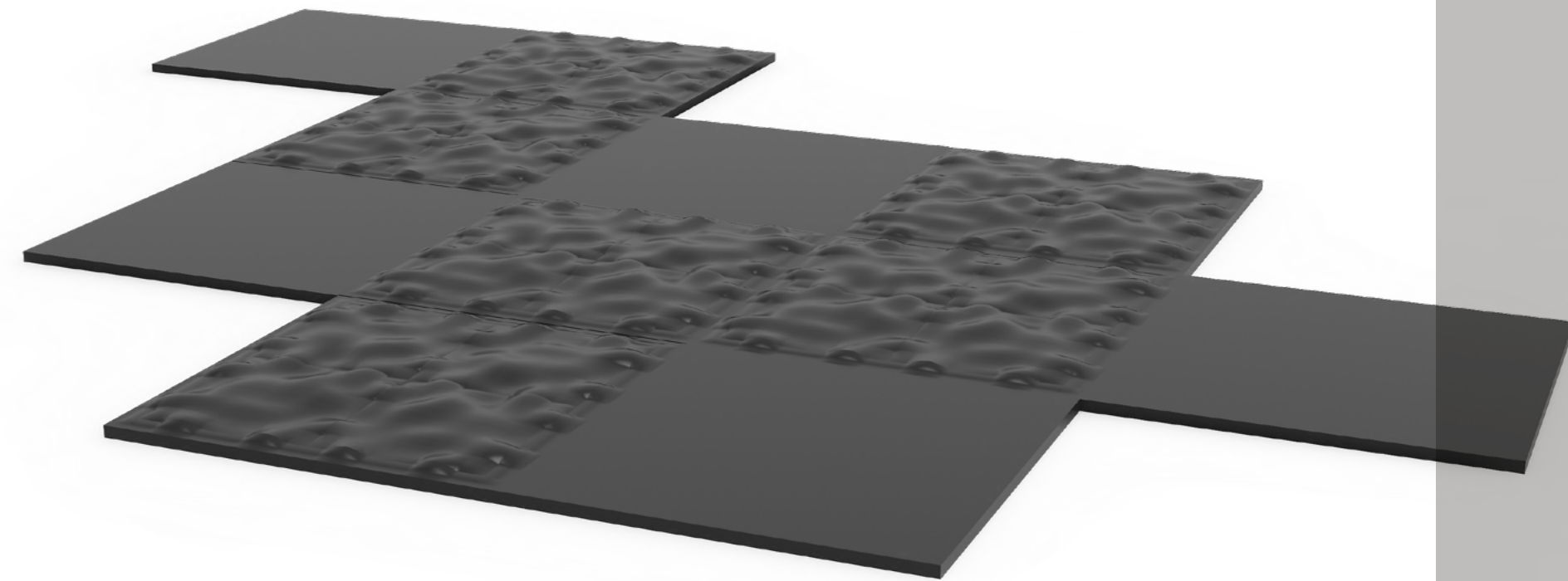

3D MAT

RE 1043

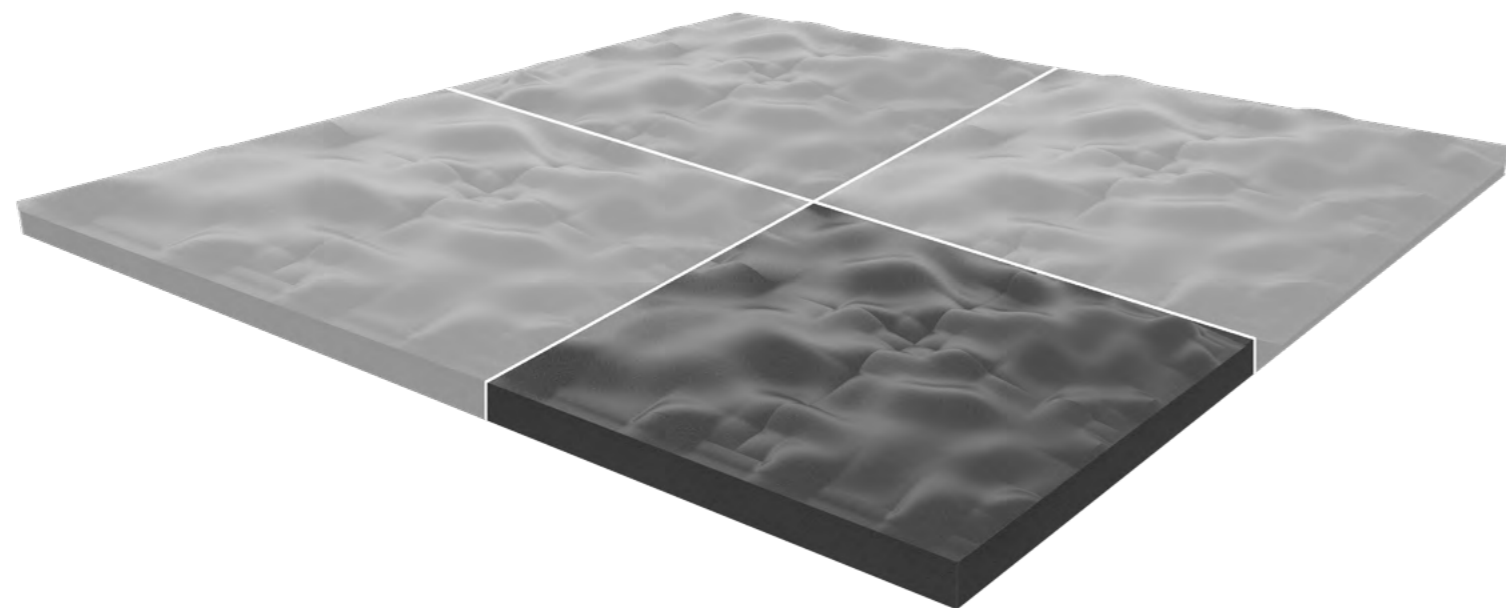

EACH PART

LENGTH	CM IN	100,00 39,37
HEIGHT	CM IN	6,00 2,36
WIDTH	CM IN	100,00 39,37

SOFT MAT 50 - 4 PACK

RE 1044

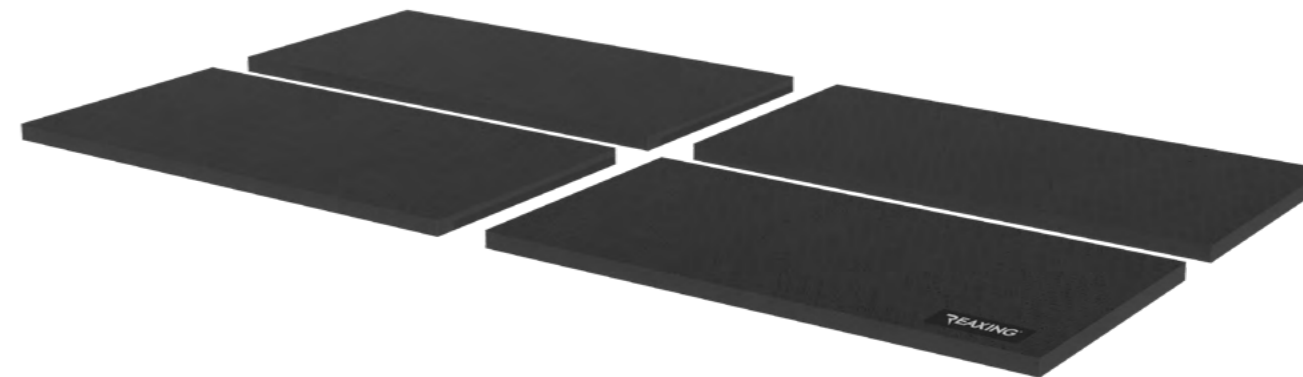

EACH PART

LENGTH	CM IN	50,00 19,69
HEIGHT	CM IN	3,00 1,18
WIDTH	CM IN	100,00 39,37

SOFT MAT 200

RE 1045



LENGTH	CM IN	200,00 78,74
HEIGHT	CM IN	3,00 1,18
WIDTH	CM IN	100,00 39,37

COMBINED PRODUCTS

Try the combined use with the suggested equipment, the instability factor will open new training frontiers, getting better results in a more engaging and rewarding way.



3D MAT WITH REAX BOARD

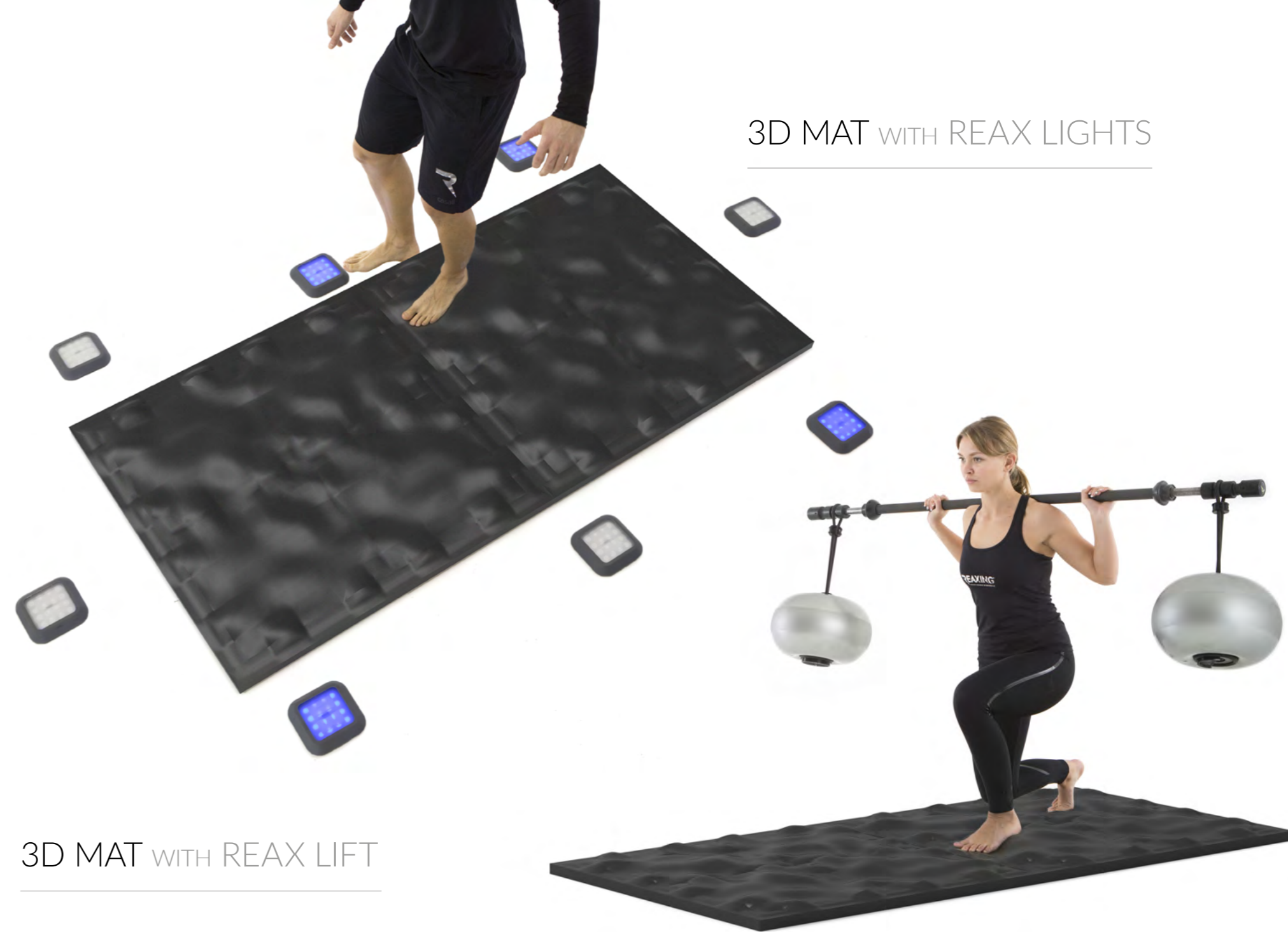

3D MAT WITH REAX LIGHTS

3D MAT WITH REAX LIFT

#READYTOREACT

PROFESSIONALS & TECHNICAL
SUPPORT



1 STRENGTH & CONDITIONING



COACHING ADVANTAGES

Several world class coaches and league champions use Reaxing, as they have seen a clear improvement in their clients performances.

2 PREVENTION & REEDUCATION



PHYSIOTHERAPIST ADVANTAGES

In the medical field, Reaxing can be considered as a new frontier for functional recovery: it opens up to various possibilities that will lead to better results.



NEUROREACTIVE TRAINING FOR HIGH PERFORMANCE

INJURY PREVENTION AND PERFORMANCE ENHANCEMENT

DEVELOPMENT

- CONDITIONAL CAPACITIES
- COORDINATIVE CAPACITIES

ENHANCEMENT

- COGNITIVE SKILLS
- PROPRIOCEPTIVE SKILLS

IMPROVEMENT

- NEURO-MOTOR EFFICIENCY
- DYNAMIC COMPETENCE



NEUROREACTIVE TRAINING FOR SPORTS REHAB

POST-INJURY RECOVERY AND RE-ATHLETIZATION

SUPPORT

- DURING REHABILITATION PHASES
- RELAPSES PREVENTION

ENHANCEMENT

- PROPRIOCEPTIVE SENSITIVITY
- FUNCTIONAL RECOVERY

IMPROVEMENT

- ADAPTIVE PROCESSES
- "RETURN TO PLAY" PHASE

WORLDWIDE SUPPORT

REAXING fully supports its partners and their activities to use Reax Solutions in the most productive way. Qualified professionals and trainers have created and developed a wide range of programs, based on the Reaxing method and suitable for any professional need.

EXPERTS SUPPORT

OUR EXPERTS ARE AT YOUR DISPOSAL TO ASSIST YOU WITH ANY TECHNICAL AND COMMERCIAL REQUESTS.

ON SITE & ON LINE TRAINING

A SPECIFIC TRAINING COURSE AND A DEDICATED VIDEO SECTION INCLUDING TUTORIALS HAVE BEEN CREATED TO HELP PROFESSIONALS EMBRACE THE REAXING METHOD.

MARKETING

WE ASSIST OUR PARTNERS WITH A SPECIFIC RANGE OF COMMERCIAL AND MARKETING TOOLS TO ACHIEVE HIGHER REVENUES AND CUSTOMER RETENTION.



EDUCATION

A WIDE RANGE OF TRAINING PROGRAMMES WITH CLEAR AND EFFECTIVE CONTENT.

An educational method to create qualified and future-oriented professionals. All our courses are developed to train the best professionals by providing them with programs adapted to their needs according to the "NEUROREACTIVE TRAINING." Reaxing educational programs are the best way to improve your knowledge about a new training methodology.



There is a training program available for each Reaxing product, with dedicated courses, which are usually held at the Reaxing Academy or at an agreed place. Each training course has its own learning materials (manuals, video tutorials, dedicated video channels).

TOP REFERENCES



SPORTS TEAMS & ACADEMIES

- 184 JUVENTUS FC / ITALY
- 185 AC MILAN / ITALY
- 186 LIVERPOOL FC / UK
- 187 AFC AJAX / THE NETHERLANDS
- 188 RMU VR46 RIDERS ACADEMY / ITALY
- 189 MOURATOGLOU TENNIS ACADEMY / FRANCE
- 190 CHINESE OLYMPIC COMMITTEE / CHINA
- 191 OLYMPIC CENTER REZEKNE / LATVIA
- 192 ITALIAN RUGBY FEDERATION / ITALY
- 193 ITALIAN VOLLEYBALL FEDERATION / ITALY

UNIVERSITY & SCHOOL

- 194 UNIVERSITY OF UTAH / USA-UT
- 195 BOSTON UNIVERSITY / USA-MA
- 196 VERONA UNIVERSITY / ITALY
- 197 FRANKFURT SCHOOL OF
FINANCE AND MANAGEMENT / GERMANY

ITALY

Juventus Football Club is a professional football club founded in 1897. The club has won 49 Italian titles, and it is the current record holder for all these competitions, meanwhile at the international stage it occupies the sixth position in Europe and the twelfth in the world for most confederation titles won with eleven trophies.

JUVENTUS FC



ITALY

AC MILAN is a professional football club founded in 1899. With 18 FIFA and UEFA trophies it holds the fourth highest record in the world (with Boca Juniors). Milan has won three Intercontinental Cups and one FIFA Club World Cup, seven European Cups, the UEFA Super Cup five times and the Cup Winners' Cup twice.

AC MILAN



Liverpool FC is one of the world's most successful football clubs with 48 major first-team awards. Liverpool Women's team has also been crowned English champion twice, while the FA Youth Cup has been won four times by the Reds.

LIVERPOOL FOOTBALL CLUB



Founded in 1900, AFC Ajax is considered as one of the largest and most legendary club in Europe. The club is one of the five teams that has earned the right to keep the European Cup and to wear the multiple-winner badge.

AFC AJAX



ITALY

The VR46 Riders Academy was founded in 2014 by Valentino Rossi, it is considered as the head quarter for training young quality Italian riders. Also, the RMU Academy is a private and professional school for two-wheel track mechanics and technicians.

RMU VR46 RIDERS ACADEMY



FRANCE

The Mouratoglou Tennis Academy is the most successful tennis academy in the world, founded in 1996 by Patrick Mouratoglou, who is considered one of the principal tennis coach in the world. Patrick has won ten Grand Slam titles since 2012 with Serena Williams. The 12-hectares sports and hotel resort is the home of 34 hard and concrete courts, alongside exceptional facilities.

MOURATOGLLOU TENNIS ACADEMY



CHINA

The Chinese Olympic Committee (COC) is a non-governmental, non-profit national sports organization with the aim of developing sports, promoting the Olympic Movement around the entire country. It represents China in handling international affairs related to the Olympic Movement.

CHINESE OLYMPIC COMMITTEE

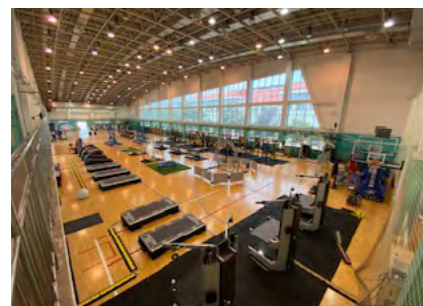

LATVIA

The Olympic Center Rezekne is a sports facility in Rezekne. It includes an ice rink, a multifunctional gym, a soccer field, gym and aerobics rooms, a sports hotel with indoor and outdoor swimming pools and an athletics track.

OLYMPIC CENTER REZEKNE



The Italian National Rugby Team represents Italy in men's international rugby union. Italy has played international rugby matches since 1929, and for decades it was considered one of the best European team outside the Five Nations Championship.

ITALIAN RUGBY FEDERATION



The Italian men's national volleyball team won three World Championships in a row, seven European Championships, one World Cup, and eight World League. The greatest achievements of the Italian women's volleyball team are: the gold medal at the 2002 FIVB Women's World Championship, and the 2 World Cups won in 2007 and in 2011.

ITALIAN VOLLEYBALL FEDERATION



The University of Utah is the main institution for higher learning in Utah. Founded in 1850, it welcomes over 31,000 students from all over the world. Additionally, It is one of the newest member of the prestigious Association of American Universities, which for more than 100 years has recognized the most outstanding academic institutions of the nation.

UNIVERSITY OF UTAH



Boston University is a private institution that was founded in 1839. With over 34,000 students from more than 130 countries, over 10,000 faculties and staff, 17 schools and colleges, the Faculty of Computing & Data Sciences, and more than 300 programs of study, its three campuses are always in high gear.

BOSTON UNIVERSITY



ITALY

The Motor Science faculty of the Verona University, constituted by the homonymous section of the Neuroscience Department, Biomedicine and Movement and by the Sports Health and Mountain Research Center of Rovereto, was ranked eighth in the 2018 edition of the "Sports Science School and Departments "Presented by the Academic Ranking of World Universities (University of Shanghai).

VERONA UNIVERSITY



GERMANY

The Frankfurt School is one of the main European leading business schools delivering German excellence in management and finance education. The FS Sustainable World Academy offers professional and executive courses focused on the advancement of the UN Sustainable Development Goals.

FRANKFURT SCHOOL OF FINANCE & MANAGEMENT



SUMMARY

REAXING Concept	4	REAX 1001	70
PHILOSOPHY	6	REAX LIGHTS PRO	110
TECHNOLOGY	8	REAX LIFT	140
METHODOLOGY	12	REAX 3D MAT	164
APPARATUS	18	SUPPORT	172
REAX RUN	20	TOP REFERENCES	178
REAX BOARD	40		

CONNECTED ALL OVER THE WORLD

OUR SHOWROOMS ARE AT YOUR DISPOSAL: DEDICATED SPACES FOR OUR PARTNERS, WHERE YOU CAN HAVE A CLEAR VISUAL AND VIRTUAL EXPERIENCE OF OUR PRODUCTS, BUT ALSO THE POSSIBILITY TO VIRTUALLY EXHIBIT OUR PRODUCTS TO YOUR OWN CLIENTS. HIGH QUALITY VIDEOS AND SOUND TO ACHIEVE THE BEST RESULTS FOR OUR CLIENTS: COME AND DISCOVER THE INNOVATIVE WORLD OF REAXING.

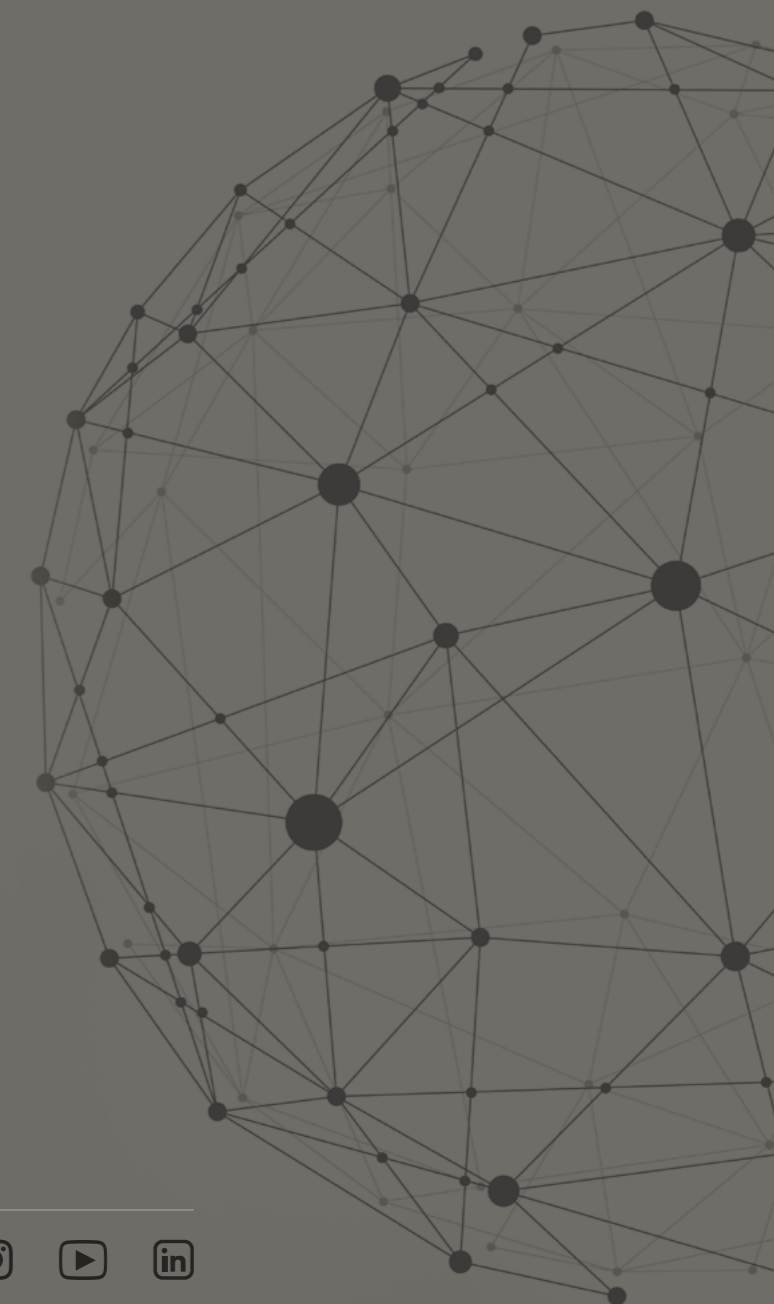

REAXING[®]

r e a x i n g . c o m